



COMMERCIAL

Refrigeration Equipment 12-Crate Milk Cooler 50" Long

ITEM # _____

MODEL # _____

NAME # _____

SIS # _____

AIA # _____

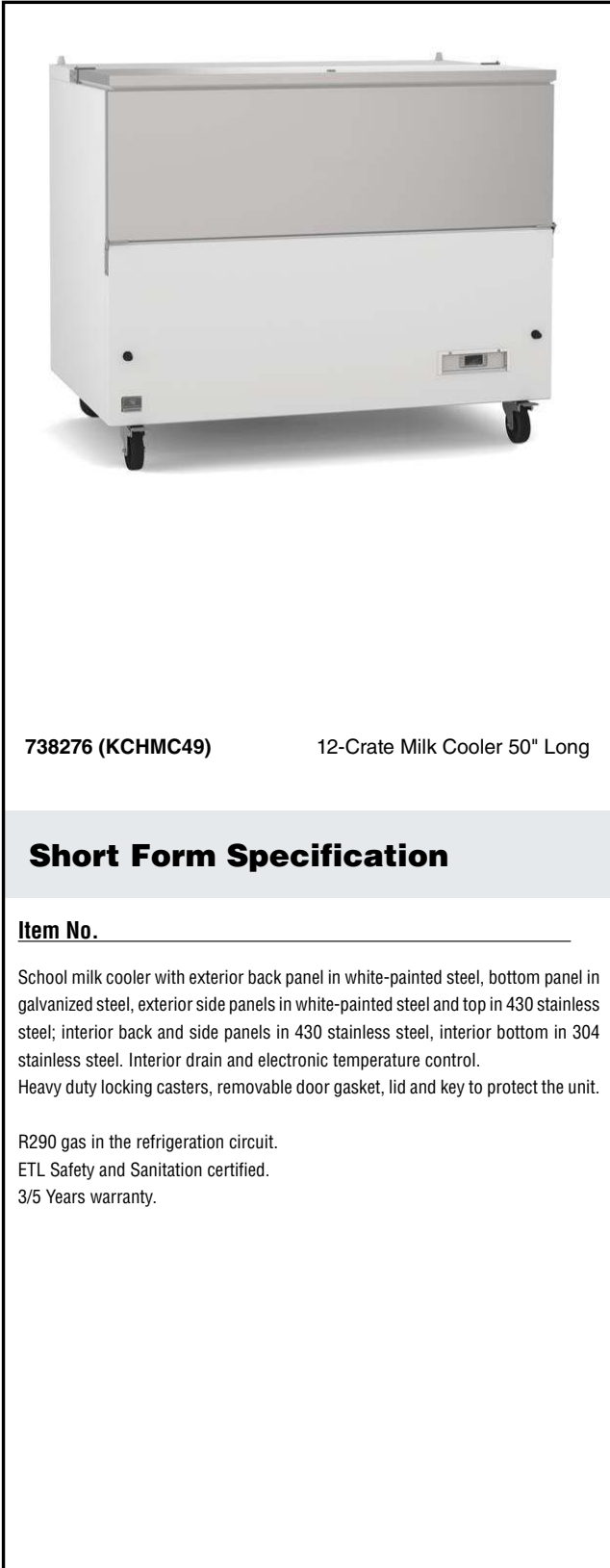

738276 (KCHMC49)

12-Crate Milk Cooler 50" Long

Short Form Specification

Item No. _____

School milk cooler with exterior back panel in white-painted steel, bottom panel in galvanized steel, exterior side panels in white-painted steel and top in 430 stainless steel; interior back and side panels in 430 stainless steel, interior bottom in 304 stainless steel. Interior drain and electronic temperature control.

Heavy duty locking casters, removable door gasket, lid and key to protect the unit.

R290 gas in the refrigeration circuit.

ETL Safety and Sanitation certified.

3/5 Years warranty.

Main Features

- External temperature display.
- Removable gasket for easy cleaning operations.
- Electronic Temperature Control, quick and simple to set, with control display for easy monitoring.
- Cabinet completely insulated with high density polyurethane for low environmental impact.

Construction

- Heavy-duty, locking casters keeps the unit in place but allow position adjusting.
- Locking lid to protect contents of the unit.
- Internal drain for easy clean out.
- Pre-wired heavy duty power cord.
- Cold Wall evaporator.

Sustainability

- CFC and HCFC free, highly ecological refrigerant type: R290 (ecological gas in foam: cyclopentane). Hydrocarbon refrigerant gas R290 for the lowest environmental impact (GWP=3), to reduce green house and ozone depletion effects.
- High efficiency components to minimize the energy consumption still guaranteeing the highest performances.
- Hydrocarbon refrigerant gas R290 for the lowest environmental impact (GWP=3) - CFC and HCFC free.

APPROVAL: _____

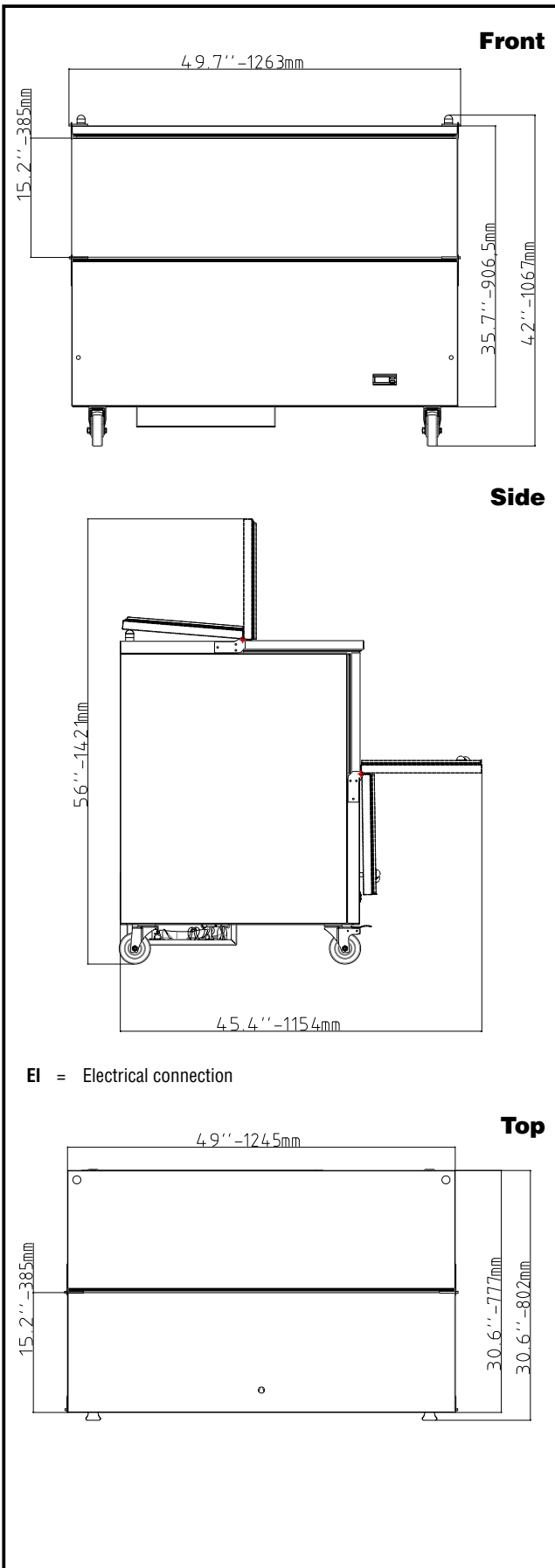

Electric

Supply voltage:

738276 (KCHMC49) 115 V/1 ph/60 Hz

Electrical power, max:

0.2 kW

Plug type:

USA NEMA 5-15P

Capacity:

Gross capacity: 18 cu.feet

Key Information:

External dimensions, Width:	49 1/32" (1245 mm)
External dimensions, Depth:	30 9/16" (777 mm)
External dimensions, Height:	42 1/64" (1067 mm)
Internal Dimensions (depth):	25 13/16"
Internal Dimensions (height):	27"
Internal Dimensions (width):	45 7/8"
Shipping height:	48 5/8" (1235 mm)
Shipping weight:	282 lbs (128 kg)
Shipping volume:	46.13 ft ³ (1.31 m ³)
Type of external material:	Prepainted white
Type of internal material:	Stainless Steel
Warranty:	3 / 5 years

Refrigeration Data

Compressor Horsepower:	1/5
Operating temperature min.:	35.6 °F
Operating temperature max.:	37.4 °F
Condenser type:	Fin & tube

Sustainability

Current consumption:	3 Amps
Refrigerant type:	R290
Refrigerant weight:	90 g