

**CONGRATULATIONS!**

You have just purchased the finest commercial refrigerator available. You can expect many years of trouble-free operation.

**TABLE OF CONTENTS**

**SAFETY INFORMATION**

Safety Precautions \_\_\_\_\_ 1  
Proper Disposal, Connecting Electricity, & Adapter Plugs \_\_\_\_\_ 2

**INSTALLATION**

Ownership & Uncrating \_\_\_\_\_ 3  
How to Connect to Electricity & Wire Gauge Chart \_\_\_\_\_ 4  
Locating and Leveling \_\_\_\_\_ 5  
Sealing Cabinet to the Floor \_\_\_\_\_ 5  
Ramp Installation \_\_\_\_\_ 6

**SETUP**

Standard Accessories \_\_\_\_\_ 7

**OPERATION**

Startup \_\_\_\_\_ 8  
Mechanical Temperature Controls Sequence of Operation \_\_\_\_\_ 9  
Electronic Temperature Controls Sequence of Operation \_\_\_\_\_ 15

**MAINTENANCE, CARE, CLEANING**

Cleaning Condenser Coil \_\_\_\_\_ 24  
Important Warranty Information \_\_\_\_\_ 25  
Stainless Steel Equipment Care and Cleaning \_\_\_\_\_ 26  
General Maintenance \_\_\_\_\_ 27

**WARRANTY**

Warranty \_\_\_\_\_ 28



STR1RRI89-1S



STR2RRT-2G-2S



INSTALLATION MANUAL

SPEC SERIES®: STR, STA & STG, ROLL-IN AND ROLL-THROUGH



## NOTICE TO CUSTOMER

**Loss or spoilage of products in your refrigerator/freezer is not covered by warranty. In addition to following recommended installation procedures you must run the refrigerator/freezer 24 hours prior to usage.**



## SAFETY INFORMATION

How to Maintain Your True Refrigerator to Receive the Most Efficient and Successful Operation.

You have selected one of the finest commercial refrigeration units made. It is manufactured under strict quality controls with only the best quality materials available. Your TRUE cooler when properly maintained will give you many years of trouble-free service.

**WARNING:** Use this appliance for its intended purpose as described in this Owner Manual.

**TO LOCATE REFRIGERANT TYPE, SEE SERIAL LABEL INSIDE CABINET.** This cabinet may contain fluorinated greenhouse gas covered by the Kyoto Protocol (please refer to cabinet's inner label for type and volume, GWP of 134a= 1,300. R404a= 3,800).

### FOR HYDROCARBON REFRIGERATION ONLY (R-290) SEE BELOW:

- **DANGER** - Risk of fire or explosion. Flammable refrigerant used. Do not use mechanical devices to defrost refrigerator. Do not puncture refrigerant tubing.
- **DANGER** - Risk of fire or explosion. Flammable refrigerant used. To be repaired only by trained service personnel. Do not puncture refrigerant tubing.
- **CAUTION** - Risk of fire or explosion. Flammable refrigerant used. Consult repair manual/owner's guide before attempting to service this product. All safety precautions must be followed.
- **CAUTION** - Risk of fire or explosion. Dispose of properly in accordance with federal or local regulations. Flammable refrigerant used.
- **CAUTION** - Risk of fire or explosion due to puncture of refrigerant tubing; follow handling instructions carefully. Flammable refrigerant used.
- **CAUTION** - Keep clear of obstruction all ventilation openings in the appliance enclosure or in the structure for building-in.

## SAFETY PRECAUTIONS

When using electrical appliances, basic safety precautions should be followed, including the following:

- This unit must be properly installed and located in accordance with the Installation Instructions before it is used.
- Do not allow children to climb, stand or hang on the shelves in the refrigerator. They could damage the unit and seriously injure themselves.
- Do not touch the cold surfaces in the freezer compartment when hands are damp or wet. Skin may stick to these extremely cold surfaces.
- Do not store or use gasoline or other flammable vapors and liquids in the vicinity of this or any other appliance. Do not store explosive substances such as aerosol cans with a flammable propellant in this appliance.

- Keep fingers out of the "pinch point" areas; clearances between the doors and between the doors and cabinet are necessarily small; be careful closing doors when children are in the area.
- Unplug the refrigerator before cleaning and making repairs.
- Setting temperature controls to the 0 position does not remove power to the light circuit, perimeter heaters, or evaporator fans.
- While cleaning condenser coil lift and hold top louvered grill. Any servicing to condensing unit remove top louvered grill.

**NOTE:** We strongly recommend that any servicing be preformed by a qualified technician.

**DANGER!****RISK OF CHILD ENTRAPMENT****PROPER DISPOSAL OF THE REFRIGERATOR**

Child entrapment and suffocation are not problems of the past. Junked or abandoned refrigerators are still dangerous... even if they will sit for "just a few days." If you are getting rid of your old refrigerator, please follow the instructions below to help prevent accidents.

**BEFORE YOU THROW AWAY YOUR OLD REFRIGERATOR OR FREEZER:**

- Take off the doors.
- Leave the shelves in place so that children may not easily climb inside.

**APPLIANCE DISPOSAL**

When recycling appliance please make sure that the refrigerants are handled according to local and national codes, requirements and regulations.

**REFRIGERANT DISPOSAL**

Your old refrigerator may have a cooling system that uses "Ozone Depleting" chemicals. If you are throwing away your old refrigerator, make sure the refrigerant is removed for proper disposal by a qualified service technician. If you intentionally release any refrigerants you can be subject to fines and imprisonment under provisions of the environmental regulations.

**USE OF EXTENSION CORDS**

**NEVER USE AN EXTENSION CORD!** TRUE will not warranty any refrigerator that has been connected to an extension cord.

**REPLACEMENT PARTS**

- Component parts shall be replaced with like components.
- Servicing shall be done by authorized service personnel, to minimize the risk of possible ignition due to incorrect parts or improper service.
- Lamps must be replaced by identical lamps only.
- If the supply cord is damaged, it must be replaced by a special cord or assembly available from the manufacturer or its service agent.

**WARNING!****HOW TO CONNECT ELECTRICITY**

**DO NOT, UNDER ANY CIRCUMSTANCES, CUT OR REMOVE THE GROUND PRONG FROM THE POWER CORD. FOR PERSONAL SAFETY, THIS APPLIANCE MUST BE PROPERLY GROUNDED.**

The power cord from this appliance is equipped with a grounding plug which minimizes the possibility of electric shock hazard.

Have the wall outlet and circuit checked by a qualified electrician to make sure the outlet is properly grounded.

If the outlet is a standard 2-prong outlet, it is your personal responsibility and obligation to have it replaced with the properly grounded wall outlet.

The refrigerator should always be plugged into its own individual electrical circuit, which has a voltage rating that matches the rating plate.

This provides the best performance and also prevents overloading building wiring circuits which could cause a fire hazard from overheated wires.

Never unplug your refrigerator by pulling on the power cord. Always grip plug firmly and pull straight out from the outlet.

Repair or replace immediately all power cords that have become frayed or otherwise damaged. Do not use a cord that shows cracks or abrasion damage along its length or at either end.

When removing the refrigerator away from the wall, be careful not to roll over or damage the power cord.

If supply power cord is damaged it should be replaced with original equipment manufacture parts. To avoid hazard this should be done by a qualified service technician.

**USE OF ADAPTER PLUGS**

**NEVER USE AN ADAPTER PLUG!** Because of potential safety hazards under certain conditions, we strongly recommend against the use of an adapter plug.

The incoming power source to the cabinet including any adapters used must have the adequate power available and must be properly grounded. Only adapters listed with UL should be used.

**NORTH AMERICA USE ONLY!**

NEMA plugs

TRUE uses these types of plugs. If you do not have the right outlet have a certified electrician install the correct power source.

**NOTE:** International plug configurations vary by voltage and country.



# INSTALLATION

## OWNERSHIP

To ensure that your unit works properly from the first day, it must be installed properly. We highly recommend a trained refrigeration mechanic and electrician install your TRUE equipment. The cost of a professional installation is money well spent.

Before you start to install your TRUE unit, carefully inspect it for freight damage. If damage is discovered, immediately file a claim with the delivery freight carrier.

TRUE is not responsible for damage incurred during shipment.

## UNCRATING

### TOOLS REQUIRED

- Adjustable Wrench
- 1/2 inch socket (Castor Bolts)
- 3/4 inch socket (Skid Bolts)
- Level

The following procedure is recommended for uncrating the unit:

- Remove the outer packaging, (cardboard and bubbles or Styrofoam corners and clear plastic). Inspect for concealed damage. Again, immediately file a claim with the freight carrier if there is damage.
- Move your unit as close to the final location as possible before removing the wooden skid.

**NOTE: KEYS FOR COOLERS WITH DOOR LOCKS ARE LOCATED IN WARRANTY PACKETS.**

## LOCK AND KEYS

The following procedure is for locking and unlock unit:

- Insert the key and turn.
- Remove the key.

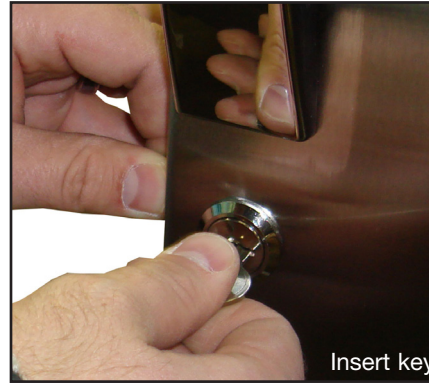

## HOW TO CONNECT ELECTRICITY

Do not, under any circumstances, cut or remove the ground prong from the power cord. For personal safety, this appliance must be properly grounded.

The power cord of this appliance is equipped with a grounding plug which mates with a standard grounding wall outlet to minimize the possibility of electric shock hazard from this appliance. Have the wall outlet and circuit checked by a qualified electrician to make sure the outlet is properly grounded. If the outlet is a standard 2-prong outlet, it is your personal responsibility and obligation to have it replaced with the properly grounded wall outlet. The unit should always be plugged into its own individual electrical circuit, which has a voltage rating that matches the rating plate. This provides the best performance and also prevents overloading building wiring circuits which could cause a fire hazard from overheated wires. Never unplug your unit by pulling on the power cord. Always grip plug firmly and pull straight out from the outlet. Repair or replace immediately all power cords that have become frayed or otherwise damaged. Do not use a cord that shows cracks or abrasion damage along its length or at either end. When removing the unit away from the wall, be careful not to roll over or damage the power cord.

## ELECTRIC INSTALLATION & SAFETY INFORMATION

- If the supply cord is damaged, it must be replaced by a special cord or assembly available from the manufacturer or its service agent.
- Lamps must be replaced by identical lamps only.
- Appliance tested according to the climate classes 5 and 7 temperature and relative humidity.

### ELECTRICAL INSTRUCTIONS

- Before your new unit is connected to a power supply, check the incoming voltage with a voltmeter. If anything less than 100% of the rated voltage for operation is noted, correct immediately.
- All units are equipped with a service cord, and must be powered at proper operating voltage at all times. Refer to cabinet data plate for this voltage.

### TRUE RECOMMENDS THAT A SOLE USE CIRCUIT BE DEDICATED FOR THE UNIT.

**WARNING:** Compressor warranties are void if compressor burns out due to low voltage.

**WARNING:** Power supply cord ground should not be removed!

**WARNING:** Do not use electrical appliances inside the food storage compartments of the appliances unless they are of the type recommended by the manufacturer.

**NOTE:** To reference wiring diagram, remove front louvered grill, wiring diagram is positioned on the inside cabinet wall.

## WIRE GAUGE CHART

| 115 Volts<br>Amps | Distance In Feet To Center of Load |    |    |    |    |    |    |    |     |     |     |     |
|-------------------|------------------------------------|----|----|----|----|----|----|----|-----|-----|-----|-----|
|                   | 20                                 | 30 | 40 | 50 | 60 | 70 | 80 | 90 | 100 | 120 | 140 | 160 |
| 2                 | 14                                 | 14 | 14 | 14 | 14 | 14 | 14 | 14 | 14  | 14  | 14  | 14  |
| 3                 | 14                                 | 14 | 14 | 14 | 14 | 14 | 14 | 14 | 14  | 14  | 14  | 12  |
| 4                 | 14                                 | 14 | 14 | 14 | 14 | 14 | 14 | 14 | 14  | 14  | 12  | 12  |
| 5                 | 14                                 | 14 | 14 | 14 | 14 | 14 | 14 | 14 | 12  | 12  | 12  | 10  |
| 6                 | 14                                 | 14 | 14 | 14 | 14 | 14 | 12 | 12 | 12  | 10  | 10  | 10  |
| 7                 | 14                                 | 14 | 14 | 14 | 14 | 12 | 12 | 12 | 10  | 10  | 10  | 8   |
| 8                 | 14                                 | 14 | 14 | 14 | 12 | 12 | 12 | 10 | 10  | 10  | 8   | 8   |
| 9                 | 14                                 | 14 | 14 | 12 | 12 | 12 | 10 | 10 | 10  | 8   | 8   | 8   |
| 10                | 14                                 | 14 | 14 | 12 | 12 | 10 | 10 | 10 | 10  | 8   | 8   | 8   |
| 12                | 14                                 | 14 | 12 | 12 | 10 | 10 | 10 | 8  | 8   | 8   | 8   | 6   |
| 14                | 14                                 | 14 | 12 | 10 | 10 | 10 | 8  | 8  | 8   | 6   | 6   | 6   |
| 16                | 14                                 | 12 | 12 | 10 | 10 | 8  | 8  | 8  | 8   | 6   | 6   | 6   |
| 18                | 14                                 | 12 | 10 | 10 | 8  | 8  | 8  | 8  | 8   | 6   | 6   | 5   |
| 20                | 14                                 | 12 | 10 | 10 | 8  | 8  | 8  | 6  | 6   | 6   | 5   | 5   |
| 25                | 12                                 | 10 | 10 | 8  | 8  | 6  | 6  | 6  | 6   | 5   | 4   | 4   |
| 30                | 12                                 | 10 | 8  | 8  | 6  | 6  | 6  | 6  | 5   | 4   | 4   | 3   |
| 35                | 10                                 | 10 | 8  | 6  | 6  | 6  | 5  | 5  | 4   | 4   | 3   | 2   |
| 40                | 10                                 | 8  | 8  | 6  | 6  | 5  | 5  | 4  | 4   | 3   | 2   | 2   |
| 45                | 10                                 | 8  | 6  | 6  | 6  | 5  | 4  | 4  | 3   | 3   | 2   | 1   |
| 50                | 10                                 | 8  | 6  | 6  | 5  | 4  | 4  | 3  | 3   | 2   | 1   | 1   |

| 230 Volts<br>Amps | Distance In Feet To Center of Load |    |    |    |    |    |    |    |     |     |     |     |
|-------------------|------------------------------------|----|----|----|----|----|----|----|-----|-----|-----|-----|
|                   | 20                                 | 30 | 40 | 50 | 60 | 70 | 80 | 90 | 100 | 120 | 140 | 160 |
| 5                 | 14                                 | 14 | 14 | 14 | 14 | 14 | 14 | 14 | 14  | 14  | 14  | 14  |
| 6                 | 14                                 | 14 | 14 | 14 | 14 | 14 | 14 | 14 | 14  | 14  | 14  | 12  |
| 7                 | 14                                 | 14 | 14 | 14 | 14 | 14 | 14 | 14 | 14  | 14  | 14  | 12  |
| 8                 | 14                                 | 14 | 14 | 14 | 14 | 14 | 14 | 14 | 14  | 14  | 12  | 12  |
| 9                 | 14                                 | 14 | 14 | 14 | 14 | 14 | 14 | 14 | 14  | 12  | 12  | 10  |
| 10                | 14                                 | 14 | 14 | 14 | 14 | 14 | 14 | 12 | 12  | 12  | 10  | 10  |
| 12                | 14                                 | 14 | 14 | 14 | 14 | 14 | 12 | 12 | 12  | 10  | 10  | 10  |
| 14                | 14                                 | 14 | 14 | 14 | 14 | 12 | 12 | 12 | 10  | 10  | 10  | 8   |
| 16                | 14                                 | 14 | 14 | 14 | 12 | 12 | 12 | 10 | 10  | 10  | 8   | 8   |
| 18                | 14                                 | 14 | 14 | 12 | 12 | 12 | 10 | 10 | 10  | 8   | 8   | 8   |
| 20                | 14                                 | 14 | 14 | 12 | 10 | 10 | 10 | 10 | 10  | 8   | 8   | 8   |
| 25                | 14                                 | 14 | 12 | 12 | 10 | 10 | 10 | 8  | 8   | 8   | 6   | 6   |
| 30                | 14                                 | 12 | 12 | 10 | 10 | 10 | 8  | 8  | 8   | 6   | 6   | 6   |
| 35                | 14                                 | 12 | 10 | 10 | 10 | 8  | 8  | 8  | 8   | 6   | 6   | 5   |
| 40                | 14                                 | 12 | 10 | 10 | 8  | 8  | 8  | 6  | 6   | 6   | 5   | 5   |
| 50                | 12                                 | 10 | 10 | 8  | 6  | 6  | 6  | 6  | 6   | 5   | 4   | 4   |
| 60                | 12                                 | 10 | 8  | 6  | 6  | 6  | 6  | 6  | 5   | 4   | 4   | 3   |
| 70                | 10                                 | 10 | 8  | 6  | 6  | 6  | 5  | 5  | 4   | 4   | 2   | 2   |
| 80                | 10                                 | 8  | 8  | 6  | 6  | 5  | 5  | 4  | 4   | 3   | 2   | 2   |
| 90                | 10                                 | 8  | 6  | 6  | 5  | 5  | 4  | 4  | 3   | 3   | 1   | 1   |
| 100               | 10                                 | 8  | 6  | 6  | 5  | 4  | 4  | 3  | 3   | 2   | 1   | 1   |

## LOCATING

1. Make sure unit is as close to the final location as possible.
2. Remove the shipping bolts located at the bottom of the wooden skid.
3. Carefully slide the unit off the wooden skid. Slide packing material underneath the side of the unit hanging off the skid. Then install castors or legs for that side of the unit.
4. Then carefully slide the other side of the unit off one corner at a time while installing castors or legs for each corner. Use packing material for under each corner of the unit before installing a castor or leg.

### CLEARANCES

|               | TOP      | SIDES | BACK |
|---------------|----------|-------|------|
| STR, STA, STG | 12" Open | 0"    | 1"   |

**WARNING: WARRANTY IS VOID IF VENTILATION IS INSUFFICIENT.**



Removing shipping bolts

## LEVELING

- A. Set unit in its final location. Be sure there is adequate ventilation in your room. Under extreme heat conditions, (100°F+, 38°C+), you may want to install an exhaust fan.

**WARNING: WARRANTY IS VOID IF VENTILATION IS INSUFFICIENT.**

- B. Proper leveling of your TRUE cooler is critical to operating success (for non-mobile models). Effective condensate removal and door operation will be effected by leveling.
- C. The cooler should be leveled front to back and side to side with a level.
- D. Ensure that the drain hose or hoses are positioned in the pan.
- E. Free plug and cord from inside the lower rear of the cooler (do not plug in).
- F. The unit should be placed close enough to the electrical supply so that extension cords are never used.
- G. Appliance tested according to the climate classes 5 and 7 for temperature and relative humidity.

**NOTE:** If the cabinet has a center leveling screw, castor, or leg, make sure it is adjusted properly so it makes full contact with the floor after the cabinet has been leveled.

**WARNING: CABINET WARRANTIES ARE VOID IF OEM POWER CORD IS TAMPERED WITH. TRUE WILL NOT WARRANTY ANY UNITS THAT ARE CONNECTED TO AN EXTENSION CORD.**

## SEALING CABINET TO FLOOR

**STEP 1 - Position Cabinet** - Allow one inch between the wall and rear of the refrigerator to assure proper ventilation. For freezers 3 inches between the wall and rear of the cabinet will assure proper ventilation.

**STEP 2 - Level Cabinet** - Cabinet should be level, side to side and front to back. Place a carpenter's level in the interior floor in four places:

- A. Position level in the inside floor of the unit near the doors. (Level should be parallel to cabinet front). Level cabinet.
- B. Position level at the inside rear of cabinet. (Again level should be placed parallel to cabinet back).
- C. Perform similar procedures to steps A & B by placing the level on inside floor (left and right sides - parallel to the depth of the cooler). Level cabinet.

**STEP 3** - Draw an outline on the base on the floor.

**STEP 4** - Raise and block the front side of the cabinet.

**STEP 5** - Apply a bead of "NSF Approved Sealant", (see list below), to floor on half inch inside the outline drawn. The bead must be heavy enough to seal the entire cabinet surface when it is down on the sealant.

**STEP 6** - Raise and block the rear of the cabinet

**STEP 7** - Apply sealant on floor as outlined in Step 5 on other three sides.

**STEP 8** - Examine to see that cabinet is sealed to floor around entire perimeter.

**NOTE:** Asphalt floors are very susceptible to chemical attack. A layer of tape on the floor prior to applying the sealant will protect the floor.

### NSF APPROVED SEALANTS:

1. Minnesota Mining #ECU800 Caulk
2. Minnesota Mining #ECU2185 Caulk
3. Minnesota Mining #ECU1055 Bead
4. Minnesota Mining #ECU1202 Bead
5. Armstrong Cork - Rubber Caulk
6. Products Research Co. #5000 Rubber Caulk
7. G.E. Silicone Sealer
8. Dow Corning Silicone Sealer

## ROLL-IN & ROLL-THRU RAMP INSTALLATION

Once the cabinet is in its final location and level the roll-in ramp can be installed. The ramp has three slotted holes in back. These slotted holes slide over three thumb screws located in the front of the cabinet near the floor.

Be sure the doors are closing smoothly and not binding up on the ramp. To adjust door sweeper gasket, loosen slotted thumbscrews. The gasket can then be moved up or down and side to side. The gasket should make some contact with the ramp when the door is closing. This can be checked by opening up the door 3-4" and allowing the door to close. This process may have to be done several times before securing the sweeper gasket bracket. Once gasket is properly adjusted, tighten slotted thumbscrews.



## DOOR SWEEP GASKET ADJUSTMENT

To adjust door sweeper gasket, loosen slotted thumbscrews. The gasket can then be moved up or down and side to side. The gasket should make some contact with the ramp when the door is closing. This can be checked by opening up the door 3-4" and allowing the door to close. This process may have to be done several times before securing the sweeper gasket bracket. Once gasket is properly adjusted, tighten slotted thumbscrews. See image 5.



# SETUP

## STANDARD ACCESSORIES

### DOOR CONFIGURATION:

After installing, cabinet doors can be adjusted for alignment. The hinge on the door and hinge on the cabinet can be adjusted accordingly.

#### STEP 1

To remove door open at a 90° angle from the cabinet and lift door up and out from the cabinet hinges carefully avoiding rainshield. Rest the door in a safe area.

#### STEP 2

Remove gray plastic cover from hinge located on the cabinet. (See image 1). Use a standard screw driver and pry out the gray cover. This exposes the three Phillips screws anchoring the hinge to the cabinet. (See image 2). Loosen these three screws but don't remove them. Adjustment can be made slightly up/down and side to side.

#### STEP 3

The hinge on the cabinet door can also be adjusted. Remove cover from hinge located on the door: Pull on the cover directly out from the door. (See image 3). This exposes the three Phillips screws anchoring the hinge to the door. Loosen these three screws but don't remove them. The hinge can be moved side to side, up and down. (See image 4).

**NOTE: WHEN TIGHTENING THE HINGES TO THE CABINET AND DOOR DO NOT APPLY PRESSURE TO THE PHILLIPS SCREWS. CAREFULLY ANCHOR THEM WITHOUT APPLYING EXTREME AMOUNTS OF PRESSURE.**

#### STEP 4

To adjust the lock latch remove two Phillips screws and the latch can be put to the side for later reinstallation. (See image 5). The lock base that anchors the latch can be adjusted simply by loosening the two Phillips screws, but not removing them. Then the lock base can be moved side to side for adjustment. (See image 6). After adjustment is complete tighten the lock base and install the latch back into place.

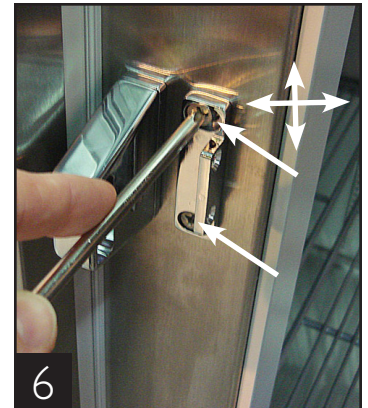
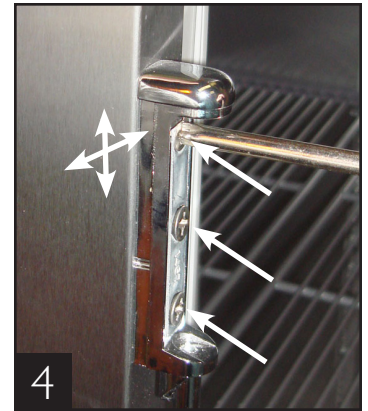
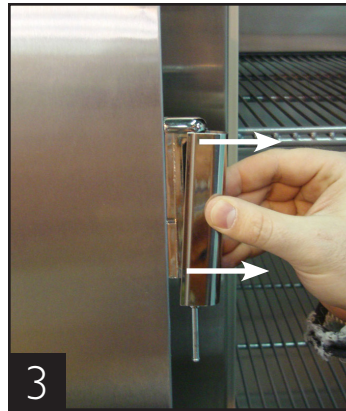
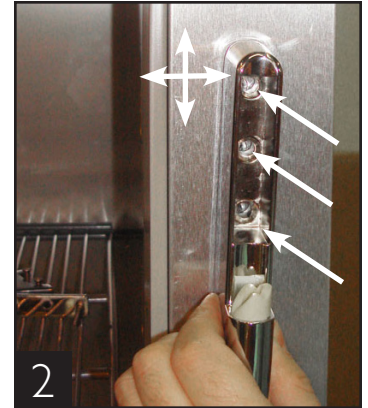



# OPERATION

## STARTUP

- A. The compressor is ready to operate. Plug in the cooler.
- B. Temperature controls are factory-set to give refrigerators an approximate temperature of 35°F (1.6°C) and freezers an approximate temperature of -10°F (-23.3°C). Allow unit to function several hours, completely cooling cabinet before changing the control setting.

Temperature Control Location and Settings.

- Temperature control type will vary upon model and age of cabinet.
- Mechanical control or electronic control without display:
  - Inside cabinet
  - Behind cabinet
  - Behind front or rear access grill
- Electronic control with display:
  - In countertop
  - In top louvered panel
  - In or behind bottom louvered grill

See website for adjustments, sequence of operation, and more information.

- C. Excessive tampering with the control could lead to service difficulties. Should it ever become necessary to replace temperature control, be sure it is ordered from your TRUE dealer or recommended service agent.
- D. Good air flow in your TRUE unit is critical. Be careful to load product so that it neither presses against the back wall, nor comes within four inches of the evaporator housing. Refrigerated air off the coil must circulate down the back wall.

**NOTE:** If the unit is disconnected or shut off, wait five minutes before starting again.

**RECOMMENDATION** - Before loading product we recommend you run your TRUE unit empty for two to three days. This allows you to be sure electrical wiring and installation are correct and no shipping damage has occurred. Remember, our factory warranty does not cover product loss!

### LIGHT SWITCH LOCATION:

Light switch location depends upon the model. Most instances the switch is located next to the temperature control.

### ENERGY-SAVER SWITCH

With the “-” mark in the down position, this will indicate that the ENERGY SAVER FUNCTION is OFF and will activate the door/frame heaters. With the “0” mark in the down position, this will indicate that the ENERGY SAVER FUNCTION is ON and will deactivate the door/frame heaters.



## DIGITAL TEMPERATURE DISPLAY

The digital temperature display can view °C or °F. To achieve this, there is a small plug that will need to be removed to achieve °C reading. See image 1 for temperature display location. If the plug is kept in the back of the digital display °F will be viewable. See images for reference. When temperature display is in °C mode place the plug in a safe place so it can be easily reinstalled for °F reading.

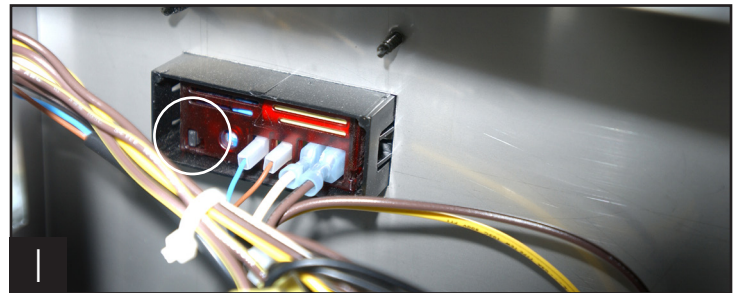

Rear of Rainshield



# MECHANICAL TEMPERATURE CONTROLS

## COIL SENSING

An evaporator coil sensing temperature control ensures that the evaporator coil will remain clear of frost and ice by not allowing the compressor to restart until the coil temperature is above the freezing temperature. This is considered an **off cycle defrost**.

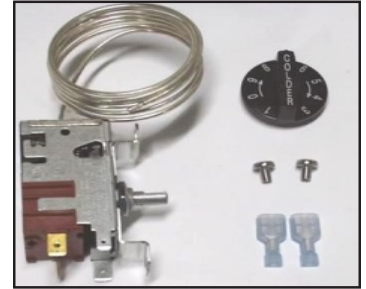

## AIR SENSING

An air sensing temperature control used in a freezer application will require a defrost cycle with heaters to ensure that the evaporator coil is kept clear of frost and ice.

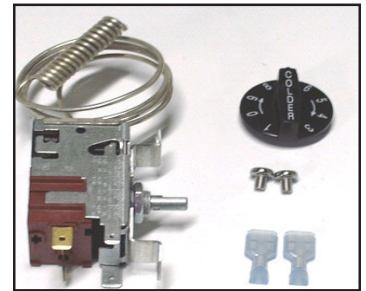

## MECHANICAL TEMPERATURE CONTROL GENERAL SEQUENCE OF OPERATION

### MECHANICAL CONTROL REFRIGERATOR GENERAL SEQUENCE OF OPERATION

1. Cabinet is plugged in.
  - a. Interior lights will illuminate on Glass Door Models only. If lights do not come on verify the light switch is in the "ON" position. Solid door cabinets may or may not have lights that may be controlled by the door switch.
2. The compressor and evaporator fans will start if the temperature control is calling for cooling. (If the compressor does not start, verify that the temperature control is not in the "OFF" or "0" position.)
3. The temperature control may cycle the compressor and evaporator fan(s) on and off together:
  - a. The temperature control is sensing the evaporator coil temperature.
  - b. The temperature control should be set on the #4 or #5.
  - c. The warmest setting is #1, the coldest is #9, and #0 is the off position.
  - d. The thermometer is designed to read and display a cabinet temperature not a product temperature. The thermometer may reflect the refrigeration cycle swings of up and down temperatures. The most accurate temperature on a cabinet's operation is to verify the product temperature.
4. There is not a defrost timer as the temperature control will initiate the off-cycle defrost during each refrigeration cycle.
  - a. At this time, the compressor will and the evaporator fan(s) may turn off. Defrost heaters are not installed on refrigerators and therefore will not be energized.
  - b. After the evaporator coil temperature has been reached, as determined by the temperature control, the compressor will restart.
5. There may be a timer located on the condensing unit base. This timer is not used for a defrost event. The timer will change the rotation of the reversing condenser fan motor.

## **MECHANICAL CONTROL FREEZER GENERAL SEQUENCE OF OPERATION**

1. Cabinet is plugged in.
  - a. Interior lights will illuminate on glass door models only. If lights do not come on, verify the light switch is in the "ON" position. Solid door cabinets may or may not have lights that may be controlled by the door switch.
2. The compressor only will start if the temperature control is calling for cooling. (If the compressor does not start, verify that the temperature control is not in the "OFF" or "0" position or the cabinet is not in a defrost event.)
  - a. The evaporator fan(s) will remain off until a specific temperature of the evaporator coil is reached.
3. The temperature control may cycle the compressor and evaporator fan(s) on and off together.
  - a. The temperature control is sensing the air temperature.
  - b. The temperature control should be set on the #4 or #5.
  - c. The warmest setting is #1, the coldest is #9, and #0 is the off position.
  - d. The thermometer is designed to read and display a cabinet temperature not a product temperature. The thermometer may reflect the refrigeration cycle swings of up and down temperatures. The most accurate temperature on a cabinet's operation is to verify the product temperature.
4. The defrost timer will initiate defrost during specific times of day.
  - a. At this time, the compressor and evaporator fan(s) will turn off and the evaporator coil heater and drain tube heater will be energized. Some cabinets may also change the rotation of the reversing condenser fan motor.
  - b. After the predetermined evaporator coil temperature has been reached or duration for defrost has expired, the compressor will restart and the evaporator fan(s) will remain off until a specific temperature of the evaporator coil is reached.

**WHEN TO MAKE AN ADJUSTMENT TO A MECHANICAL TEMPERATURE CONTROL**

We advise to make a mechanical temperature control adjustment only for a high altitude location.



**HOW TO ADJUST A MECHANICAL TEMPERATURE CONTROL**

**OPERATION INSTRUCTIONS:**

**REQUIRED TOOLS:**

- Jewelers Screw Driver (Small Screw Driver)

**GE CONTROL INSTRUCTIONS:**

The scale to the right may be used as a guide for measuring degrees of rotation required for altitude correction. See Figure 1. The arrows indicate direction of screw rotation. Turn calibration screw clockwise to obtain warmer operating temperatures.

**NOTE:** Each 1/4 turn of the calibration screw is equal to approximately 2 degrees F. Do not make more than 3/4 turn. After making adjustment, measure temperature during three cycles before adjusting again.

**NOTE:** Only adjust the screw (small flathead) on the face of the control (next to the cam). See Figure 3. Follow the Altitude Correction Table to the right.

| ALTITUDE CORRECTION TABLE:<br>CALIBRATION SCREW ADJUSTS<br>BOTH CUT-IN AND CUT-OUT |                 |
|--|-----------------|
| Altitude (Feet)  | Clockwise Turns |
| 2000   | 7/60            |
| 3000   | 11/60           |
| 4000   | 15/60           |
| 5000   | 19/60           |
| 6000   | 23/60           |
| 7000   | 27/60           |
| 8000   | 30/60           |
| 9000   | 34/60           |
| 10,000   | 37/60           |

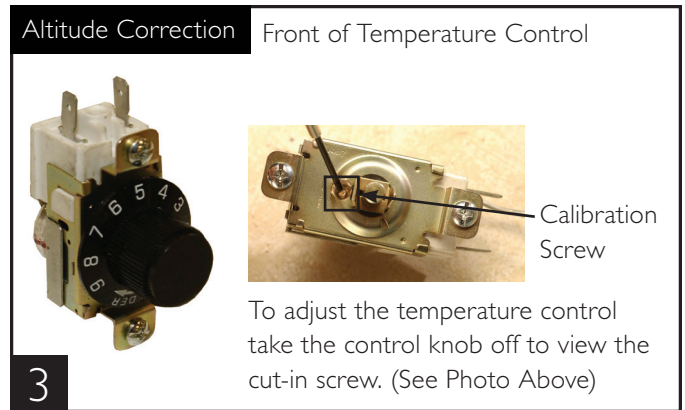
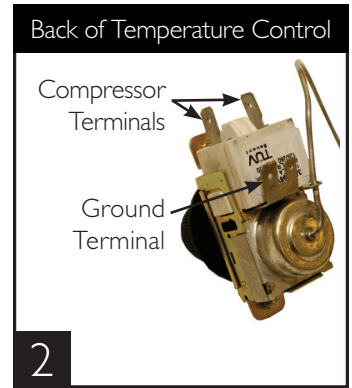
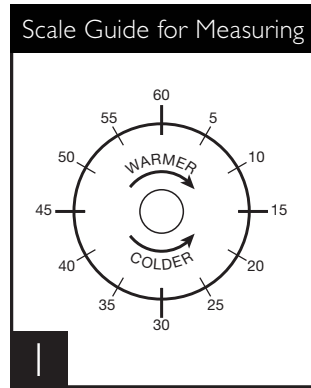

To adjust the temperature control take the control knob off to view the cut-in screw. (See Photo Above)

**INSTALLATION INSTRUCTIONS  
DANFOSS TEMPERATURE CONTROL ADJUSTMENT  
FOR HIGH ALTITUDE APPLICATIONS:**

**REQUIRED TOOLS:**

- Allen Wrench (5/64")
- Torx Screw (T-7)

**TERMS:**

**Cut-out** - Temperature sensed by the controller that shuts the compressor off.

**Cut-in** - Temperature sensed by the controller that turns the compressor on.

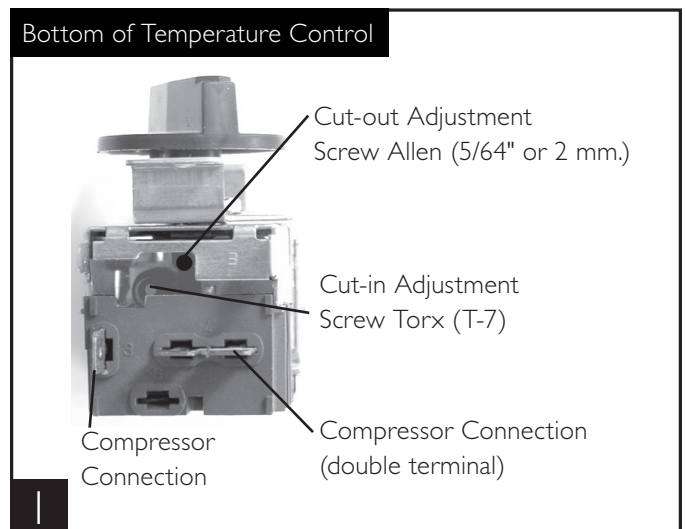

### INSTRUCTIONS: DANFOSS TEMPERATURE CONTROL ADJUSTMENT FOR HIGH ALTITUDE APPLICATIONS

**STEP 1** - Unplug cooler.

**STEP 2** - Remove the screws that secure the temperature control to the inset box.

**STEP 3** - To make these adjustments it may be necessary to remove the temperature control from the housing.

**NOTE:** You may have to remove the wires attached to the control. Take note as to which wire is on which spade terminal.

**STEP 4** - Pull out gently from cabinet.

**NOTE:** Mechanical temperature controllers are affected when functioning at high altitude. The cut-in and cut-out temperatures will be colder than when the controller functions closer to sea level.

**STEP 5** - For high elevation installations, it may be necessary to “warm-up” the set points. To make the adjustment, insert the appropriate tool in each adjustment screw and turn 1/4 of a revolution clockwise (to the right). This procedure will adjust both the cut-in and cut-out about 2°F warmer.

**STEP 6** - Make sure to reconnect the wires to the proper spade terminal when reinstalling.

### INSTALLATION INSTRUCTIONS TEMPERATURE CONTROL ALTITUDE ADJUSTMENT:

#### REQUIRED TOOLS:

- Allen Wrench (5/64")
- Torx Screw (T-7)

The scale to the right may be used as a guide for measuring degrees of rotation required for altitude correction. The arrows indicate direction of screw rotation. See Figure 1.

**IMPORTANT:** Upright models ordered with “High Altitude” temperature controls are pre-calibrated and do not require adjustment.

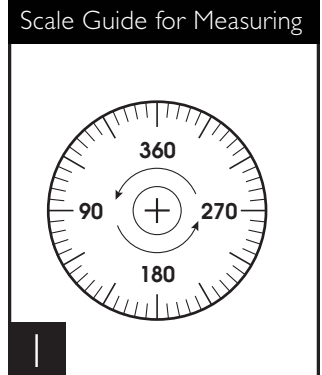

### INSTRUCTIONS: CUTLER HAMMER TEMPERATURE CONTROL ALTITUDE ADJUSTMENT

**STEP 1** - Unplug cooler.

**STEP 2** - Turn the temperature control to the “9” position.

**STEP 3** - Remove the screws that secure the mounting plate to the evaporator top. See Figure 2.

**STEP 4** - Pull control down gently from housing.

**STEP 5** - Turn screws counterclockwise (CCW).

**STEP 6** - Reassemble to cooler housing and return the temperature control to the “5” position.

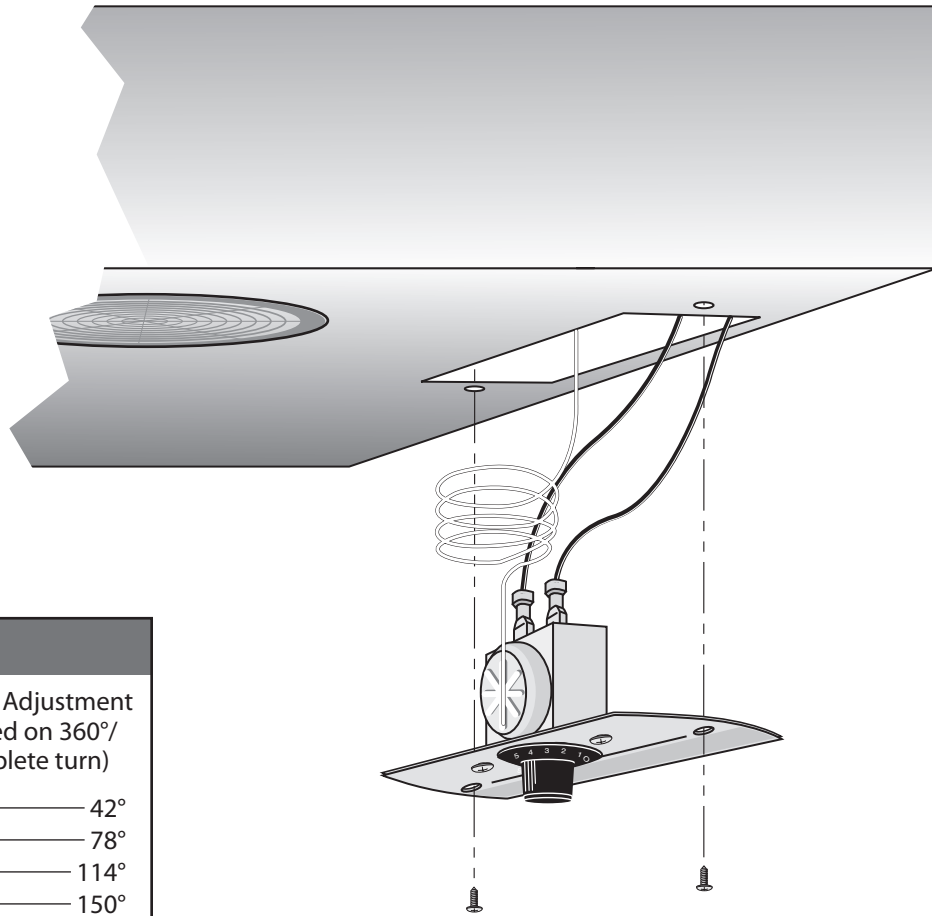

**CHART**

| Height  | CCW Adjustment<br>(based on 360°/<br>complete turn) |
|---------|---|
| 2000'   | 42°   |
| 3000'   | 78°   |
| 4000'   | 114°  |
| 5000'   | 150°  |
| 6000'   | 186°  |
| 7000'   | 222°  |
| 8000'   | 258°  |
| 9000'   | 294°  |
| 10,000' | 330°  |

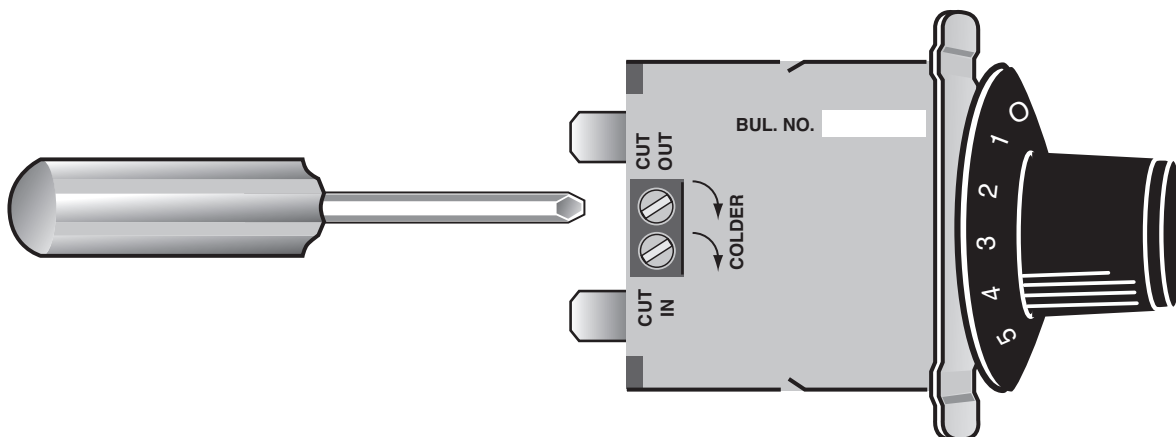

## DEFROST TIMER

### DEFROST TIME CLOCK OPERATION FOR UNITS WITH MECHANICAL CONTROL

#### RECOMMENDED DEFROST SETTINGS:

TRUE Manufacturing has factory set your defrost time clock to a recommended time and duration defrost scenario. All refrigeration equipment operating below 30°F will accumulate frost on the evaporator coil and will require routine defrost. Your TRUE equipment has been designed for three defrost periods (6:00 a.m., 2:00 p.m. and 10:00 p.m.). If you decide to deviate from these defrost time settings please follow the procedures for adjustment below.

#### TOOLS REQUIRED

- Phillips Head Screwdriver
- 1/4" Nut Driver or Socket

#### SETTING THE TIMER:

UNPLUG UNIT FROM POWER SUPPLY! DO NOT SET THE TIME BY ROTATING THE "OUTER" DIAL.

Turn the minute hand clockwise until the time of day on the outer dial is aligned with the triangle marker on the inner dial (two o'clock position).

#### ADJUSTING THE DEFROST TIMER:

Your TRUE freezer contains a defrost system that is temperature terminated, however the time clock has been designed with a time termination back-up so that the defrost period will not exceed thirty minutes. While TRUE requires a minimum 3 defrost periods not to exceed 30 minutes the procedure on this page should be followed to customize your specific needs.

**NOTICE:** If timer is not set for a minimum of 3 defrost per day for 30 minutes each, the coil may develop excessive frost. This may lead to system failure and product loss, which is not covered under warranty.

The following procedure may be followed to customize your needs.

High usage, high temperature, and high humidity may require 4 defrost settings per day.

**WARNING:** Always follow the manufacturer's recommended settings when programming the amount and duration of the defrost cycles.

**STEP 1:** The white tabs located on the outmost area of the time clock have been factory set for (6:00 a.m., 2:00 p.m., and 10:00 p.m.). Each tab represents 15 minutes of defrost time. Notice that at each defrost time two white tabs are set for 15 minutes each for a total of 30 minutes of defrost.

**STEP 2:** In order to program the time to begin the defrost cycle, flip the white tabs out to set the defrost time. To eliminate a defrost time flip the white tabs back toward the center of the Defrost Timer.

**STEP 3:** TRUE recommends a 30 minute defrost cycle three times per day.

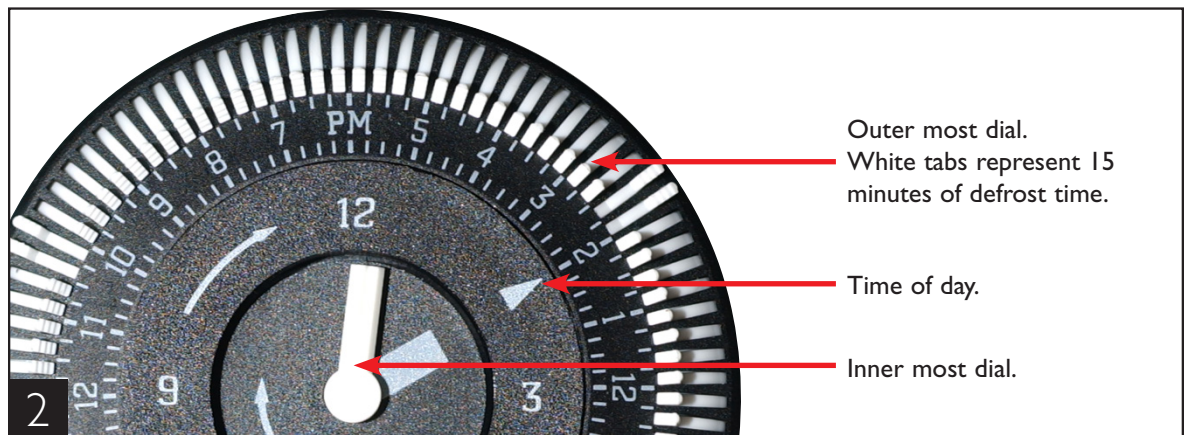
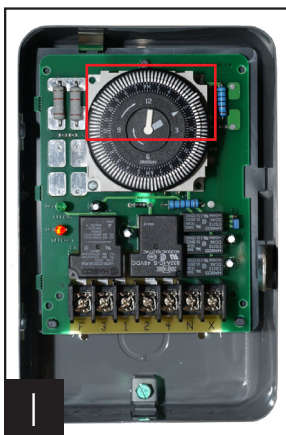

# ELECTRONIC TEMPERATURE CONTROLS

## LAE ELECTRONIC TEMPERATURE CONTROL GENERAL SEQUENCE OF OPERATION

t1 = Thermostat

t2 = Defrost

t3 = Display

t3 probe is not installed and / or activated in all applications

when t3 is not installed and / or activated, the display probe is t1.



## LAE ELECTRONIC CONTROL GENERAL SEQUENCE OF OPERATION

1. Cabinet is plugged in.
  - a. Display will illuminate.
  - b. Interior light will illuminate on Glass Door Models only. Solid door cabinet lights are controlled by the door switch.
2. After the LAE control preprogrammed time delay of up to 6 minutes, the compressor and evaporator fan(s) will start if the control is calling for cooling.
  - a. Control or condenser fans may be already pre-programmed from the factory so at the start of every compressor cycle or during a defrost cycle, the condenser fan(s) will reverse for 30 seconds to blow dirt off the condensing coil.
3. The LAE control will cycle the compressor but may also cycle evaporator fan(s) on and off determined by the Set-Point and Differential temperatures.
  - a. The Set-Point is the adjustable preprogrammed temperature which shuts off the compressor and evaporator fan(s). This is not the programmed cabinet temperature.
  - b. The Differential is the non adjustable preprogrammed temperature that is added to the Set-Point temperature that will restart the compressor and evaporator fan(s).
  - c. The LAE control is designed to read and display a cabinet temperature **not a product temperature.** This cabinet temperature may reflect the refrigeration cycle of the Set-Point and its Differential, or it may show an average temperature. The most accurate temperature on a cabinets operation is to verify the product temperature.

**Example: If the Set-Point is -9°F/-23°C and the Differential is 10°F/5°C**

$$\text{(Set-Point) } -9^{\circ}\text{F} + 10 \text{ (Differential)} = 1^{\circ}\text{F}$$

Or

$$\text{(Set-Point) } -23^{\circ}\text{C} + 5 \text{ (Differential)} = -18^{\circ}\text{C}$$

**The compressor and evaporator fan(s) will cycle off -9°F/-23°C and back on at 1°F/-18°C**

4. The LAE control may be preprogrammed to initiate defrost by interval or at specific times of day.
  - a. At this time the "dEF" will appear on the display and compressor will turn off until a preprogrammed temperature or duration is reached. During this time for freezers only, evaporator fan(s) will also turn off and the coil heater and drain tube heaters will also be energized. Some cabinets may also change the rotation of the reversing condenser fan motor.
  - b. After the preprogrammed temperature or duration for defrost has been reached there may be a short delay for both the compressor and evaporator fans to restart. At this time "dEF" may still appear on the display for a short time.



## HOW TO DIAGNOSE AN LAE ELECTRONIC CONTROL

Indicator lights for Refrigeration/Heating Mode, Fan Operation, Defrost Mode.

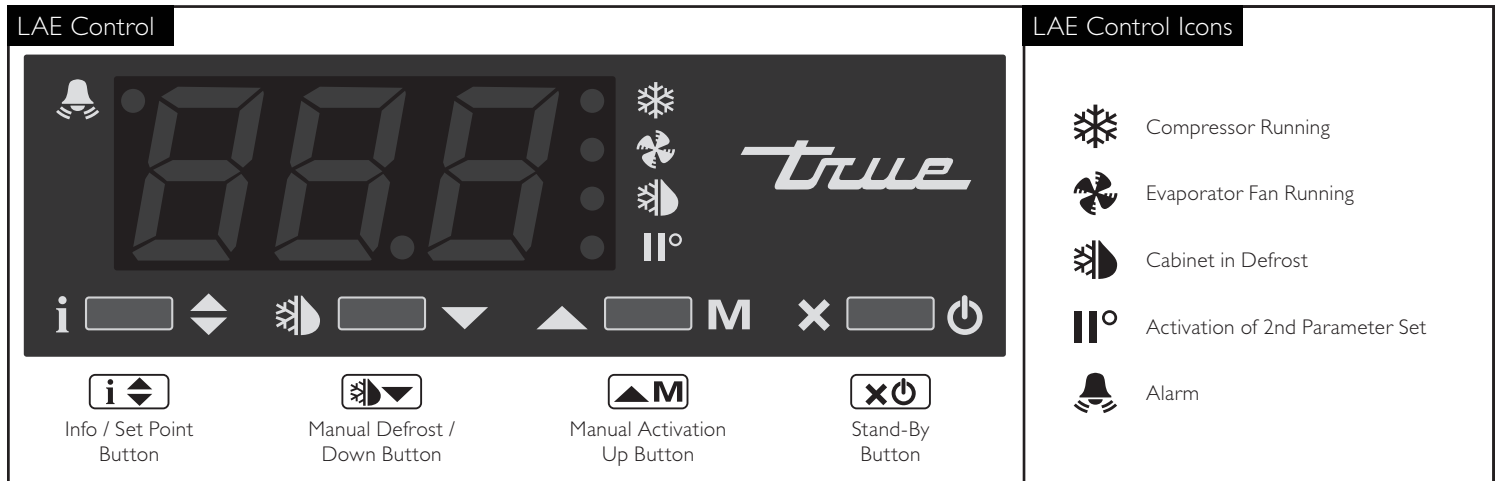

## USING THE LAE ELECTRONIC CONTROL



### LOCKING AND UNLOCKING THE LAE CONTROLLER:

**WHY:** Locking of control is necessary to prevent changes to program that may affect cabinet operation.

#### HOW TO LOCK AND UNLOCK LAE CONTROLLER:

**STEP 1** - To change lock setting press and release the Info button . "tl" will appear. See image 1.

**STEP 2** - Press the Down button  until "Loc" appears. See image 2.

**STEP 3** - While pressing and holding the Info button  press the Up  or Down  button to change the lock settings. If "no" appears, the controller is unlocked. If "yes" appears, the controller is locked. See images 3 and 4.

**STEP 4** - Once the lock setting has been set correctly release the info button . Wait 5 seconds for the display to show temperature. See image 5.



Image 3: If "no" appears on screen, the controller is unlocked.



Image 4: If "yes" appears on screen, the controller is locked.



LAE Control



Info / Set Point Button



Manual Defrost / Down Button



Manual Activation Up Button



Stand-By Button

**HOW TO TURN OFF THE LAE ELECTRONIC CONTROL:**

May need to unlock control.

**WHY:** Turning off the control will deactivate all electrical components.

**CAUTION:** Turning off the control will not shut off power to the cabinet. Cabinet must be unplugged prior to any repair.

**HOW TO TURN OFF THE LAE ELECTRONIC CONTROL:**

**STEP 1** - To turn off control, press and hold the Stand-by button  until "OFF" appears. Release Stand-by button. See Image 2.

**STEP 2** - To turn on control, repeat prior steps and a temperature will appear.



**TURNING THE GLASS DOOR MODEL LIGHTS ON AND OFF:**

May need to unlock control.

**WHY:** Light may be controlled by LAE Controller or interior light switch.



**HOW TO TURN THE GLASS DOOR MODEL LIGHT ON AND OFF:**

**STEP 1** - To control interior / sign lights by the LAE Controller, press and release the Manual Activation button .

**STEP 2** - To control interior / sign lights by the interior door switch, depress the rocker switch to the "ON" position. Light switch is located on inside top right of the ceiling.



(Solid Door model lights are controlled by a door switch)

## LAE Control

Info / Set Point  
ButtonManual Defrost /  
Down ButtonManual Activation  
Up ButtonStand-By  
Button**CHANGING THE "SET POINT":**



May need to unlock control.

**WHY:** The set point is the temperature at which the compressor will shut off.

**NOTE:** The "set point" *IS NOT* the cabinet holding temperature.

**HOW TO CHANGE THE "SET POINT":**

**STEP 1** - To see the set point, press and hold the Info button . See image 1.

**STEP 2** - While still holding the Info button , press the Up  or Down  button to change the "set point".

**STEP 3** - Once the "set point" has been set correctly release the Info button . The display will show temperature. See image 2.

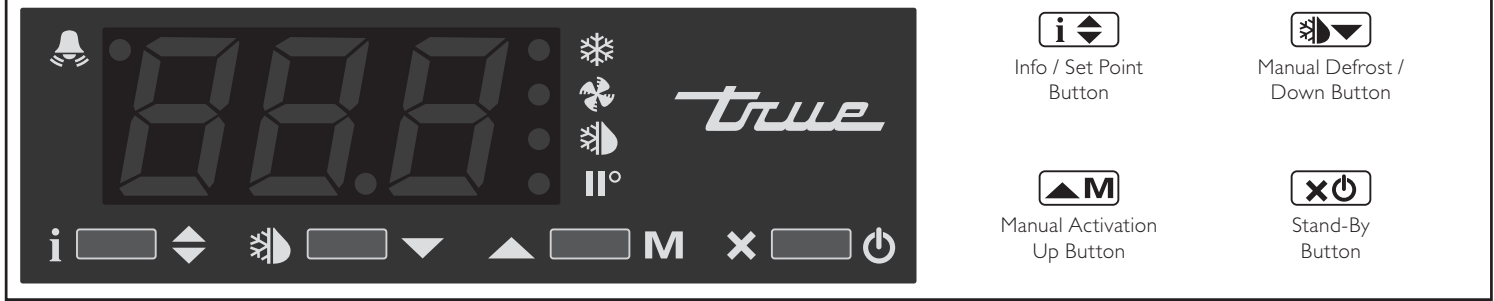

## LAE Control

**INITIATE A MANUAL DEFROST:**

May need to unlock control.

**WHY:** A one time additional defrost may be necessary to clear accumulated frost / ice from evaporator coil.



**HOW TO INITIATE A MANUAL DEFROST:**

*The method to initiate a manual defrost is determined by the Defrost Mode Parameter "DTM" preprogrammed in the controller.*

**REGULAR TIME DEFROST (TIM)**

If controller is preprogrammed for "TIM", press and release the Manual Defrost button  until "dEF" appears.

**REAL TIME CLOCK (RTC)**

If controller is preprogrammed for "RTC" press the and hold the Manual Defrost button  for 5 seconds until "dh1" appears. Release the Manual Defrost button  and then press and hold for an additional 5 seconds until "dEF" appears.

**NOTE:** Defrost will only terminate once a specific preset temperature or a preset time duration is reached.

## LAE Control



Info / Set Point  
Button



Manual Defrost /  
Down Button



Manual Activation  
Up Button



Stand-By  
Button



**CHANGING “DEFROST INTERVALS”:**

May need to unlock control.

This can only be changed if defrost mode parameter “DFM” is set for “TIM”.

**WHY:** The defrost interval is the time duration between defrost cycles. The defrost interval time starts when the cabinet is supplied power or after a manual defrost.



**HOW TO CHANGE “DEFROST INTERVALS”:**

**STEP 1** - To see the set point, press and hold the Info button  and the Stand-by button  at the same time.

**NOTE:** Depending on the version of control, one of three parameters will appear: “ScL” image 1a, “SPL” image 1b, “MdL” image 1c.

**STEP 2** - Push the Up button  until “dFt” appears. See image 2.

**STEP 3** - Press and hold the Info button  to see the defrost interval time. See image 3.

**STEP 4** - While pressing and holding the Info button , press the Up  or Down  button to change the defrost interval times (higher the number the less frequent the cabinet will defrost).

**STEP 5** - Once the defrost interval time has been changed, release the Info button .

**STEP 6** - Wait 30 seconds for the display to show temperature. See image 4.



## LAE Control



Info / Set Point  
ButtonManual Defrost /  
Down ButtonManual Activation  
Up ButtonStand-By  
Button**HOW TO CHANGE DISPLAY READOUT FROM FAHRENHEIT TO CELSIUS:**

May need to unlock control.

This can NOT be changed with the LAE model AR2-28 version of the control. See page 32 for more information.



**WHY:** Changing readout will assist with customer application.

**HOW TO CHANGE DISPLAY READOUT FROM FAHRENHEIT TO CELSIUS:**

**STEP 1** - To change the display, press and hold the Info button  and the Stand-by button  at the same time. "Mdl" or "SPL" will appear. See images 1a and 1b.

**STEP 2** - Push the Down button  until "SCL" appears. See image 2.

**STEP 3** - Press and hold the Info button  to see the "readout scale". See image 3.

**STEP 4** - While pressing and holding the Info button , press the up  or down  button to change the "readout scale". See image 4.

**STEP 5** - Once the "readout scale" has been changed, release the info button .

**STEP 6** - Wait 30 seconds for the display to show temperature. See image 5.





## LAE Control

Info / Set Point  
ButtonManual Defrost /  
Down ButtonManual Activation  
Up ButtonStand-By  
Button**DISPLAYING TEMPERATURE PROBES, T1, T2, T3:**



**WHY:** To display temperature probe readings in different locations of the cabinet.

**HOW TO DISPLAY PROBE TEMPERATURES:**

**STEP 1** - To display T1 temperature, press and release the info button . "t1" will appear. See image 1.

**STEP 2** - Press and hold the info button . This is the temperature of the T1 Probe. See image 2.

**STEP 3** - By releasing the info button , "t2" will appear. Press and hold the info button  to display the temperature of the T2 probe.

**STEP 4** - By releasing the info button  again, "t3" will appear. Press and hold the info button  to display the temperature of the T3 probe. (If probe T3 is not activated, "t3" will not appear of the display.)

**DISPLAY CODES**

| DISPLAY |                                |     |                                      |
|---------|--------------------------------|-----|--------------------------------------|
| dEF     | Defrost in progress            | hi  | Room high temperature alarm          |
| oFF     | Controller in stand-by         | Lo  | Room low temperature alarm           |
| do      | Door open alarm                | E1  | Probe T1 failure                     |
| t1      | Instant Probe 1 temperature    | E2  | Probe T2 failure                     |
| t2      | Instant Probe 2 temperature    | E3  | Probe T3 failure                     |
| t3      | Instant Probe 3 temperature    | thi | Maximum probe 1 temperature recorded |
| n in    | Minutes of the Real Time Clock | tLo | Minimum probe 1 temperature recorded |
| hr      | Hours of the Real Time Clock   | Loc | Keypad state lock                    |

**LAE CONTROLLER PARAMETER SETTINGS FOR CELSIUS**

For LAE control model AR2-28 ONLY, ALL parameters with a formula shown need to be converted for Celsius applications.

**EXAMPLE:**

If current SPL is set for 20 degrees F the formula is  $(X-32) / 1.8$

$(20-32) / 1.8 = -6.7$  Celsius

| AR2-28 |                |      |                |
|--------|----------------|------|----------------|
| SCL    | 1C             | ADO  |                |
| SPL    | $(X-32) / 1.8$ | AHM  |                |
| SPH    | $(X-32) / 1.8$ | AHT  | $(X-32) / 1.8$ |
| SP     | $(X-32) / 1.8$ | ACC  |                |
| C-H    |                | IISM |                |
| HYS    | $(X) / 1.8$    | IISL | $(X-32) / 1.8$ |
| CRT    |                | IISH | $(X-32) / 1.8$ |
| CT1    |                | IISP | $(X-32) / 1.8$ |
| CT2    |                | IIHY | $(X) / 1.8$    |
| CSD    |                | IIFC |                |
| DFM    |                | HDS  |                |
| DFT    |                | IIDF |                |
| DH1    |                | SB   |                |
| DH2    |                | DS   |                |
| DH3    |                | DSM  |                |
| DH4    |                | DI2  |                |
| DH5    |                | STT  |                |
| DH6    |                | EDT  |                |
| DLI    | $(X-32) / 1.8$ | LSM  |                |
| DTO    |                | OA1  |                |
| DTY    |                | OA2  |                |
| DPD    |                | CD   |                |
| DRN    |                | INP  |                |
| DDM    |                | OS1  | $(X) / 1.8$    |
| DDY    |                | T2   |                |
| FID    |                | OS2  | $(X) / 1.8$    |
| FDD    | $(X-32) / 1.8$ | T3   |                |
| FTO    |                | OS3  | $(X) / 1.8$    |
| FCM    |                | TLD  |                |
| FDT    | $(X) / 1.8$    | TDS  |                |
| FDH    | $(X) / 1.8$    | AVG  |                |
| FT1    |                | SIM  |                |
| FT2    |                | ADR  |                |
| FT3    |                |      |                |
| ATM    |                |      |                |
| ALA    | $(X-32) / 1.8$ |      |                |
| AHA    | $(X-32) / 1.8$ |      |                |
| ALR    | $(X) / 1.8$    |      |                |
| AHR    | $(X) / 1.8$    |      |                |
| ATI    |                |      |                |
| ATD    |                |      |                |



# MAINTENANCE, CARE, CLEANING

## CLEANING THE CONDENSER COIL

When using electrical appliances, basic safety precautions should be followed, including the following. Disconnect power to unit.

### TOOLS REQUIRED

- Phillips Screwdriver
- Stiff Bristle Brush
- Adjustable Wrench
- Air Tank or CO2 Tank
- Vacuum Cleaner

**STEP 1:** Disconnect power to unit.

**STEP 2:** Remove all screws securing top screen to unit. See image 1.

**STEP 3:** Clean off accumulated dirt from the condenser coil and the fan with a stiff bristle brush. After brushing the components off vacuum all dirt residue from the coil, fan, and surrounding areas. See image 2.

**NOTE:** If you cannot completely clean the condensing coil due to its position, then the front louvered panel will need to be removed. See Images 3 and 4.



Rainshield removal, top screws.



Rainshield removal, bottom screws.

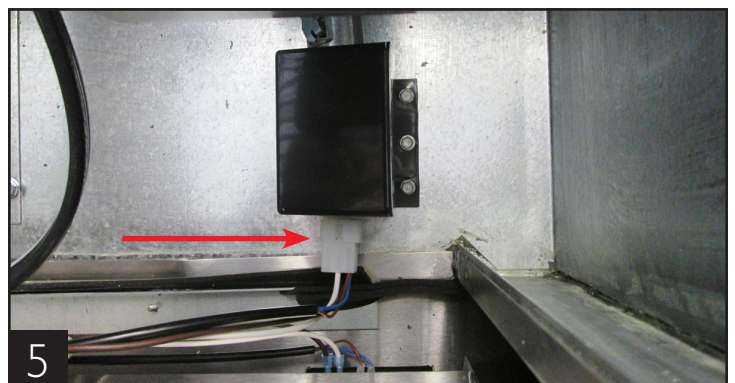

Disconnect digital temperature control connections.

## IMPORTANT WARRANTY INFORMATION

Condensers accumulate dirt and require cleaning every 30 days. Dirty condensers result in compressor failure, product loss, and lost sales... which are not covered by warranty.

If you keep the Condenser clean you will minimize your service expense and lower your electrical costs. The Condenser requires scheduled cleaning every thirty days or as needed.

Air is pulled through the Condenser continuously, along with dust, lint, grease, etc.

A dirty Condenser can result in NON-WARRANTEED part & Compressor Failures, Product Loss, and Lost Sales.

Proper cleaning involves removing dust from the Condenser. By using a soft brush, or vacuuming the Condenser with a shop vac, or using CO2, nitrogen, or pressurized air.

If you cannot remove the dirt adequately, please call your refrigeration service company.

On the Spec Series units the condenser is accessible on the top of the unit. You must lift open the cabinet rainshield to expose the Condenser. (Spec Series models)

The Condenser looks like a group of vertical fins. You need to be able to see through the condenser for the unit to function at maximum capacity. Do not place filter material in front of condensing coil. This material blocks air-flow to the coil similar to having a dirty coil.

## THE CLEANING OF THE CONDENSER IS NOT COVERED BY THE WARRANTY!

### HOW TO CLEAN THE CONDENSER:

1. Disconnect the electrical power to the unit.
2. Open the rainshield.
3. Vacuum or brush the dirt, lint, or debris from the finned condenser coil.
4. If you have a significant dirt build up you can blow out the condenser with compressed air.

### (CAUTION MUST BE USED TO AVOID EYE INJURY. EYE PROTECTION IS RECOMMENDED.)

5. When finished be sure to close the rainshield.
6. Reconnect the electrical power to the unit.

If you have any questions, please call TRUE Manufacturing at 636-240-2400 or 800-325-6152 and ask for the Service Department. Direct to Service Department 1(855)372-1368. Service Department Availability Monday-Thursday 7:00 a.m. to 7:00 p.m., Friday 7:00 a.m. to 6:00 p.m. and Saturday 8:00 a.m. to 12:00 p.m. CST.

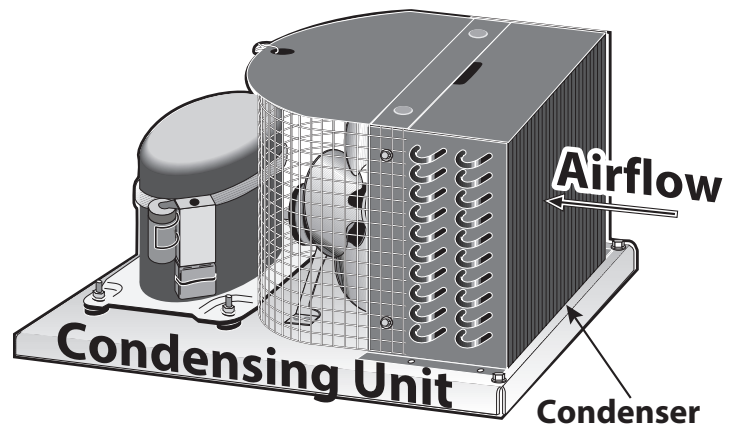

## STAINLESS STEEL EQUIPMENT CARE AND CLEANING

**CAUTION:** Do not use any steel wool, abrasive or chlorine based products to clean stainless steel surfaces.

### STAINLESS STEEL OPPONENTS

There are three basic things which can break down your stainless steel's passivity layer and allow corrosion to rear its ugly head.

1. Scratches from wire brushes, scrapers, and steel pads are just a few examples of items that can be abrasive to stainless steel's surface.
2. Deposits left on your stainless steel can leave spots. You may have hard or soft water depending on what part of the country you live in. Hard water can leave spots. Hard water that is heated can leave deposits if left to sit too long. These deposits can cause the passive layer to break down and rust your stainless steel. All deposits left from food prep or service should be removed as soon as possible.
3. Chlorides are present in table salt, food, and water. Household and industrial cleaners are the worst type of chlorides to use.

### RECOMMENDED CLEANERS FOR CERTAIN SITUATIONS / ENVIRONMENTS OF STAINLESS STEEL

- A. Soap, ammonia and detergent medallion applied with a cloth or sponge can be used for routine cleaning.
- B. Arcal 20, Lac-O-Nu Ecoshine applied provides barrier film for fingerprints and smears.
- C. Cameo, Talc, Zud First Impression is applied by rubbing in the direction of the polished lines for stubborn stains and discoloring.
- D. Easy-off and De-Grease It oven aid are excellent for removals on all finishes for grease-fatty acids, blood and burnt-on foods.
- E. Any good commercial detergent can be applied with a sponge or cloth to remove grease and oil.
- F. Benefit, Super Sheen, Sheila Shine are good for restoration / passivation.

**NOTE:** The use of stainless steel cleaners or other such solvents is not recommended on plastic parts. Warm soap and water will suffice.

## 8 STEPS THAT CAN HELP PREVENT RUST ON STAINLESS STEEL:

1. **USING THE CORRECT CLEANING TOOLS**  
Use non-abrasive tools when cleaning your stainless steel products. The stainless steel's passive layer will not be harmed by soft cloths and plastic scouring pads. Step 2 tells you how to find the polishing marks.
2. **CLEANING ALONG THE POLISH LINES**  
Polishing lines or "grain" are visible on some stainless steels. Always scrub parallel to visible lines on some stainless steels. Use a plastic scouring pad or soft cloth when you cannot see the grain.
3. **USE ALKALINE, ALKALINE CHLORINATED OR NON-CHLORIDE CONTAINING CLEANERS**  
While many traditional cleaners are loaded with chlorides, the industry is providing an ever increasing choice of non-chloride cleaners. If you are not sure of your cleaner's chloride content contact your cleaner supplier. If they tell you that your present cleaner contains chlorides, ask if they have an alternative. Avoid cleaners containing quaternary salts as they can attack stainless steel, causing pitting and rusting.
4. **WATER TREATMENT**  
To reduce deposits, soften the hard water when possible. Installation of certain filters can remove corrosive and distasteful elements. Salts in a properly maintained water softener can be to your advantage. Contact a treatment specialist if you are not sure of the proper water treatment.
5. **MAINTAINING THE CLEANLINESS OF YOUR FOOD EQUIPMENT**  
Use cleaners at the recommended strength (alkaline chlorinated or non-chloride). Avoid build-up of hard stains by cleaning frequently. When boiling water with your stainless steel equipment, the single most likely cause of damage is chlorides in the water. Heating any cleaners containing chlorides will have the same damaging effects.
6. **RINSE**  
When using chlorinated cleaners you must rinse and wipe dry immediately. It is better to wipe standing cleaning agents and water as soon as possible. Allow the stainless steel equipment to air dry. Oxygen helps maintain the passivity film on stainless steel.
7. **HYDROCHLORIC ACID (MURIATIC ACID) SHOULD NEVER BE USED ON STAINLESS STEEL**
8. **REGULARLY RESTORE/PASSIVATE STAINLESS STEEL**

## GENERAL MAINTENANCE

### LIGHT BULB REPLACEMENT (INTERIOR LIGHTS) GENERAL MAINTENANCE

**WARNING:** When replacing a light bulb make sure power to the unit is either turned off or unplugged.

Be careful when removing the light bulb. Please be aware of your local ordinances in disposing old bulbs. These bulbs should be disposed in a safe and correct manner.

- Simply unscrew the light bulb. See images 1 & 2.



Interior Light



Interior Light

**FOR ADDITIONAL MAINTENANCE INSTRUCTION,  
PLEASE VISIT THE MEDIA CENTER AT  
WWW.TRUEMFG.COM**



## WARRANTY INFORMATION (U.S.A. & CANADA ONLY!)

**THIS WARRANTY ONLY APPLIES TO UNITS SHIPPED FROM TRUE'S MANUFACTURING FACILITIES AFTER SEPTEMBER 1, 2015.**

### **THREE-YEAR PARTS & LABOR WARRANTY**

TRUE warrants to the original purchaser of every new TRUE refrigerated unit, the cabinet and all parts thereof, to be free from defects in material or workmanship, under normal and proper use and maintenance service as specified by TRUE and upon proper installation and start-up in accordance with the instruction packet supplied with each TRUE unit. TRUE's obligation under this warranty is limited to a period of three (3) years from the date of original installation or 39 months after shipment date from TRUE, whichever occurs first.

Any part covered under this warranty that are determined by TRUE to have been defective within three (3) years of original installation or thirty-nine (39) months after shipment date from manufacturer, whichever occurs first, is limited to the repair or replacement, including labor charges, of defective parts or assemblies. The labor warranty shall include standard straight time labor charges only and reasonable travel time, as determined by TRUE.

Warranty does not cover standard wear parts which include door gaskets, incandescent bulbs or fluorescent bulbs. Warranty also does not cover issues caused by improper installation or lack of basic preventative maintenance which includes regular cleaning of condenser coils.

### **ADDITIONAL TWO-YEAR COMPRESSOR WARRANTY**

In addition to the Three (3) year warranty stated above, TRUE warrants its hermetically and semi-hermetically sealed compressor to be free from defects in both material and workmanship under normal and proper use and maintenance service for a period of two (2) additional years from the date of original installation but not to exceed five (5) years and three (3) months after shipment from the manufacturer.

Compressors determined by TRUE to have been defective within this extended time period will, at TRUE's option, be either repaired or replaced with a compressor or compressor parts of similar design and capacity.

The two (2) year extended compressor warranty applies only to hermetically and semi-hermetically sealed parts of the compressor and does not apply to any other parts or components, including, but not limited to: cabinet, paint finish, temperature control, refrigerant, metering device, driers, motor starting equipment, fan assembly or any other electrical component, etcetera.

### **404A/134A/HYDROCARBON COMPRESSOR WARRANTY**

The two year compressor warranty detailed above will be voided if the following procedure is not carefully adhered to:

1. This system contains R404A, R134A, or R290 refrigerant and polyol ester lubricant. The polyol ester lubricant has rapid moisture absorbing qualities. If long exposure to the ambient conditions occur, the lubricant must be removed and replaced with new. For oil amounts and specifications please call TRUE technical service department (855-372-1368). Failure to comply with recommended lubricant specification will void the compressor warranty.

2. Drier replacement is very important and must be changed when a system is opened for servicing. An OEM exact replacement should be used. The new drier must also be the same capacity as the drier being replaced.

3. Micron level vacuums must be achieved to insure low moisture levels in the system. 500 microns or lower must be obtained.

### **WARRANTY CLAIMS**

All claims for labor or parts must be made directly through TRUE. All claims should include: model number of the unit, the serial number of the cabinet, proof of purchase, date of installation, and all pertinent information supporting the existence of the alleged defect.

In case of warranty compressor, the compressor model tag must be returned to TRUE along with above listed information.

Any action or breach of these warranty provisions must be commenced within one (1) year after that cause of action has occurred.

### **WHAT IS NOT COVERED BY THIS WARRANTY**

TRUE's sole obligation under this warranty is limited to either repair or replacement of parts, subject to the additional limitations below. This warranty neither assumes nor authorizes any person to assume obligations other than those expressly covered by this warranty.

**NO CONSEQUENTIAL DAMAGES.** TRUE IS NOT RESPONSIBLE FOR ECONOMIC LOSS; PROFIT LOSS; OR SPECIAL, INDIRECT, OR CONSEQUENTIAL DAMAGES, INCLUDING WITHOUT LIMITATION, LOSSES OR DAMAGES ARISING FROM FOOD OR PRODUCT SPOILAGE CLAIMS WHETHER OR NOT ON ACCOUNT OF REFRIGERATION FAILURE.

**WARRANTY IS NOT TRANSFERABLE.** This warranty is not assignable and applies only in favor of the original purchaser/user to whom delivered. ANY SUCH ASSIGNMENT OR TRANSFER SHALL VOID THE WARRANTIES HEREIN MADE AND SHALL VOID ALL WARRANTIES, EXPRESS OR IMPLIED, INCLUDING ANY WARRANTY OF MERCHANTABILITY OR FITNESS FOR A PARTICULAR PURPOSE.

**IMPROPER USAGE.** TRUE ASSUMES NO LIABILITY FOR PARTS OR LABOR COVERAGE FOR COMPONENT FAILURE OR OTHER DAMAGES RESULTING FROM IMPROPER USAGE OR INSTALLATION OR FAILURE TO CLEAN AND/OR MAINTAIN PRODUCT AS SET FORTH IN THE WARRANTY PACKET PROVIDED WITH THE UNIT.

**RELOCATION OF CABINET FOR REPAIR.** True is not responsible for the cost to move a cabinet for any reason from its position of operation on the customer's premises to make a warranty repair.

**NON OEM PARTS.** Use of non OEM parts without manufacturer's approval will void cabinet warranty.

**ALTERATION, NEGLIGENCE, ABUSE, MISUSE, ACCIDENT, DAMAGE DURING TRANSIT OR INSTALLATION, FIRE, FLOOD, ACTS OF GOD.** TRUE is not responsible for the repair or replacement of any parts that TRUE determines have been subjected after the date of manufacture to alteration, neglect, abuse, misuse, accident, damage during transit or installation, fire, flood, or act of God.

**IMPROPER ELECTRICAL CONNECTIONS.** TRUE IS NOT RESPONSIBLE FOR THE REPAIR OR REPLACEMENT OF FAILED OR DAMAGED COMPONENTS RESULTING FROM INCORRECT SUPPLY VOLTAGE, THE USE OF EXTENSION CORDS, LOW VOLTAGE, OR UNSTABLE SUPPLY VOLTAGE.

**NO IMPLIED WARRANTY OF MERCHANTABILITY OR FITNESS FOR A PARTICULAR PURPOSE:** THERE ARE NO OTHER WARRANTIES, EXPRESSED, IMPLIED OR STATUTORY, EXCEPT THE THREE (3) YEAR PARTS & LABOR WARRANTY AND THE ADDITIONAL TWO (2) YEAR COMPRESSOR WARRANTY AS DESCRIBED ABOVE. THESE WARRANTIES ARE EXCLUSIVE AND IN LIEU OF ALL OTHER WARRANTIES, INCLUDING IMPLIED WARRANTY AND MERCHANTABILITY OR FITNESS FOR A PARTICULAR PURPOSE. THERE ARE NO WARRANTIES WHICH EXTEND BEYOND THE DESCRIPTION ON THE FACE HEREOF.

**OUTSIDE U.S. AND CANADA:** This warranty does not apply to, and TRUE is not responsible for, any warranty claims made on products sold or used outside the United States and Canada. This warranty only applies to units shipped from True's manufacturing facilities after September 1, 2015.