

CONGRATULATIONS!

You have just purchased the finest commercial heated cabinet available. You can expect many years of trouble-free operation.

TABLE OF CONTENTS

SAFETY INFORMATION

Safety Precautions _____ 1
Proper Disposal, Connecting Electricity, & Adapter Plugs _____ 2

INSTALLATION

Ownership & Uncrating _____ 3
How to Connect to Electricity & Wire Gauge Chart _____ 4
Locating and Installation of Legs or Castors _____ 5
Leveling & Sealing Cabinet to the Floor _____ 6
Ramp Installation _____ 7
Humidification Procedure _____ 7

SETUP

Standard Accessories _____ 8

OPERATION

Startup _____ 12
Mechanical Temperature Controls Sequence of Operation _____ 12
Electronic Temperature Controls Sequence of Operation _____ 13

MAINTENANCE, CARE, CLEANING

Stainless Steel Equipment Care and Cleaning _____ 18
General Maintenance _____ 19

WARRANTY

Warranty _____ 20



INSTALLATION MANUAL

SPEC SERIES: STR, STA & STG HEATED CABINETS



NOTICE TO CUSTOMER

Loss or spoilage of products in your refrigerator/freezer is not covered by warranty. In addition to following recommended installation procedures you must run the refrigerator/freezer 24 hours prior to usage.



SAFETY INFORMATION

How to Maintain Your True Refrigerator to Receive the Most Efficient and Successful Operation.

You have selected one of the finest commercial refrigeration units made. It is manufactured under strict quality controls with only the best quality materials available. Your TRUE cooler when properly maintained will give you many years of trouble-free service.

WARNING: Use this appliance for its intended purpose as described in this Owner Manual.

SAFETY PRECAUTIONS

When using electrical appliances, basic safety precautions should be followed, including the following:

- This unit must be properly installed and located in accordance with the Installation Instructions before it is used.
- Do not allow children to climb, stand or hang on the shelves in the refrigerator. They could damage the unit and seriously injure themselves.
- Do not store or use gasoline or other flammable vapors and liquids in the vicinity of this or any other appliance. Do not store explosive substances such as aerosol cans with a flammable propellant in this appliance.

- Keep fingers out of the "pinch point" areas; clearances between the doors and between the doors and cabinet are necessarily small; be careful closing doors when children are in the area.
- Unplug the unit before cleaning and making repairs.

NOTE: We strongly recommend that any servicing be preformed by a qualified technician.

DANGER!**RISK OF CHILD ENTRAPMENT****PROPER DISPOSAL OF THE UNIT**

Child entrapment and suffocation are not problems of the past. Junked or abandoned refrigerators are still dangerous... even if they will sit for "just a few days." If you are getting rid of your old refrigerator, please follow the instructions below to help prevent accidents.

BEFORE YOU THROW AWAY YOUR OLD UNIT:

- Take off the doors.
- Leave the shelves in place so that children may not easily climb inside.

USE OF EXTENSION CORDS

NEVER USE AN EXTENSION CORD! TRUE will not warranty any refrigerator that has been connected to an extension cord.

REPLACEMENT PARTS

- Component parts shall be replaced with like components.
- Servicing shall be done by authorized service personnel, to minimize the risk of possible ignition due to incorrect parts or improper service.
- Lamps must be replaced by identical lamps only.
- If the supply cord is damaged, it must be replaced by a special cord or assembly available from the manufacturer or its service agent.

WARNING!**HOW TO CONNECT ELECTRICITY**

DO NOT, UNDER ANY CIRCUMSTANCES, CUT OR REMOVE THE GROUND PRONG FROM THE POWER CORD. FOR PERSONAL SAFETY, THIS APPLIANCE MUST BE PROPERLY GROUNDED.

The power cord from this appliance is equipped with a grounding plug which minimizes the possibility of electric shock hazard.

Have the wall outlet and circuit checked by a qualified electrician to make sure the outlet is properly grounded.

If the outlet is a standard 2-prong outlet, it is your personal responsibility and obligation to have it replaced with the properly grounded wall outlet.

The refrigerator should always be plugged into its own individual electrical circuit, which has a voltage rating that matches the rating plate.

This provides the best performance and also prevents overloading building wiring circuits which could cause a fire hazard from overheated wires.

Never unplug your refrigerator by pulling on the power cord. Always grip plug firmly and pull straight out from the outlet.

Repair or replace immediately all power cords that have become frayed or otherwise damaged. Do not use a cord that shows cracks or abrasion damage along its length or at either end.

When removing the refrigerator away from the wall, be careful not to roll over or damage the power cord.

If supply power cord is damaged it should be replaced with original equipment manufacture parts. To avoid hazard this should be done by a qualified service technician.

USE OF ADAPTER PLUGS

NEVER USE AN ADAPTER PLUG! Because of potential safety hazards under certain conditions, we strongly recommend against the use of an adapter plug.

The incoming power source to the cabinet including any adapters used must have the adequate power available and must be properly grounded. Only adapters listed with UL should be used.

NORTH AMERICA USE ONLY!

NEMA plugs

TRUE uses these types of plugs. If you do not have the right outlet have a certified electrician install the correct power source.

NOTE: International plug configurations vary by voltage and country.



INSTALLATION

OWNERSHIP

To ensure that your unit works properly from the first day, it must be installed properly. We highly recommend a trained refrigeration mechanic and electrician install your TRUE equipment. The cost of a professional installation is money well spent.

Before you start to install your TRUE unit, carefully inspect it for freight damage. If damage is discovered, immediately file a claim with the delivery freight carrier.

TRUE is not responsible for damage incurred during shipment.

UNCRATING

TOOLS REQUIRED

- Adjustable Wrench
- 1/2 inch socket (Castor Bolts)
- 3/4 inch socket (Skid Bolts)
- Level

The following procedure is recommended for uncrating the unit:

- Remove the outer packaging, (cardboard and bubbles or Styrofoam corners and clear plastic). Inspect for concealed damage. Again, immediately file a claim with the freight carrier if there is damage.
- Move your unit as close to the final location as possible before removing the wooden skid.

NOTE: KEYS FOR COOLERS WITH DOOR LOCKS ARE LOCATED IN WARRANTY PACKETS.

LOCK AND KEYS

The following procedure is for locking and unlock unit:

- Insert the key and turn.
- Remove the key.

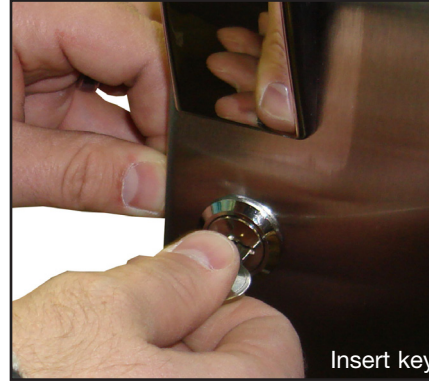

HOW TO CONNECT ELECTRICITY

Do not, under any circumstances, cut or remove the ground prong from the power cord. For personal safety, this appliance must be properly grounded.

The power cord of this appliance is equipped with a grounding plug which mates with a standard grounding wall outlet to minimize the possibility of electric shock hazard from this appliance. Have the wall outlet and circuit checked by a qualified electrician to make sure the outlet is properly grounded. If the outlet is a standard 2-prong outlet, it is your personal responsibility and obligation to have it replaced with the properly grounded wall outlet. The unit should always be plugged into its own individual electrical circuit, which has a voltage rating that matches the rating plate. This provides the best performance and also prevents overloading building wiring circuits which could cause a fire hazard from overheated wires. Never unplug your unit by pulling on the power cord. Always grip plug firmly and pull straight out from the outlet. Repair or replace immediately all power cords that have become frayed or otherwise damaged. Do not use a cord that shows cracks or abrasion damage along its length or at either end. When removing the unit away from the wall, be careful not to roll over or damage the power cord.

ELECTRIC INSTALLATION & SAFETY INFORMATION

- If the supply cord is damaged, it must be replaced by a special cord or assembly available from the manufacturer or its service agent.
- Lamps must be replaced by identical lamps only.
- Appliance tested according to the climate classes 5 and 7 temperature and relative humidity.

ELECTRICAL INSTRUCTIONS

- Before your new unit is connected to a power supply, check the incoming voltage with a voltmeter. If anything less than 100% of the rated voltage for operation is noted, correct immediately.
- All units are equipped with a service cord, and must be powered at proper operating voltage at all times. Refer to cabinet data plate for this voltage.

TRUE RECOMMENDS THAT A SOLE USE CIRCUIT BE DEDICATED FOR THE UNIT.

WARNING: Power supply cord ground should not be removed!

NOTE: To reference wiring diagram, remove front louvered grill, wiring diagram is positioned on the inside cabinet wall.

WIRE GAUGE CHART

115 Volts Amps	Distance In Feet To Center of Load											
	20	30	40	50	60	70	80	90	100	120	140	160
2	14	14	14	14	14	14	14	14	14	14	14	14
3	14	14	14	14	14	14	14	14	14	14	14	12
4	14	14	14	14	14	14	14	14	14	14	12	12
5	14	14	14	14	14	14	14	12	12	12	10	10
6	14	14	14	14	14	14	12	12	12	10	10	10
7	14	14	14	14	14	12	12	12	10	10	10	8
8	14	14	14	14	12	12	12	10	10	10	8	8
9	14	14	14	12	12	12	10	10	10	8	8	8
10	14	14	14	12	12	10	10	10	10	8	8	8
12	14	14	12	12	10	10	10	8	8	8	8	6
14	14	14	12	10	10	10	8	8	8	6	6	6
16	14	12	12	10	10	8	8	8	8	6	6	6
18	14	12	10	10	8	8	8	8	8	6	5	5
20	14	12	10	10	8	8	8	6	6	6	5	5
25	12	10	10	8	8	6	6	6	6	5	4	4
30	12	10	8	8	6	6	6	5	4	4	3	3
35	10	10	8	6	6	6	5	5	4	4	3	2
40	10	8	8	6	6	5	5	4	4	3	2	2
45	10	8	6	6	6	5	4	4	3	3	2	1
50	10	8	6	6	5	4	4	3	3	2	1	1

230 Volts Amps	Distance In Feet To Center of Load											
	20	30	40	50	60	70	80	90	100	120	140	160
5	14	14	14	14	14	14	14	14	14	14	14	14
6	14	14	14	14	14	14	14	14	14	14	14	12
7	14	14	14	14	14	14	14	14	14	14	14	12
8	14	14	14	14	14	14	14	14	14	14	12	12
9	14	14	14	14	14	14	14	14	14	12	12	10
10	14	14	14	14	14	14	14	12	12	12	10	10
12	14	14	14	14	14	14	12	12	12	10	10	10
14	14	14	14	14	14	12	12	12	10	10	10	8
16	14	14	14	14	12	12	12	10	10	10	8	8
18	14	14	14	12	12	12	10	10	10	8	8	8
20	14	14	14	12	10	10	10	10	10	8	8	8
25	14	14	12	12	10	10	10	8	8	8	6	6
30	14	12	12	10	10	10	8	8	8	6	6	6
35	14	12	10	10	10	8	8	8	8	6	6	5
40	14	12	10	10	8	8	8	6	6	6	5	5
50	12	10	10	8	6	6	6	6	5	4	4	4
60	12	10	8	6	6	6	6	5	4	4	3	3
70	10	10	8	6	6	6	5	5	4	4	2	2
80	10	8	8	6	6	5	5	4	4	3	2	2
90	10	8	6	6	5	5	4	4	3	3	1	1
100	10	8	6	6	5	4	4	3	3	2	1	1

LOCATING

1. Make sure unit is as close to the final location as possible.
2. Remove the shipping bolts located at the bottom of the wooden skid.
3. Carefully slide the unit off the wooden skid. Slide packing material underneath the side of the unit hanging off the skid. Then install castors or legs for that side of the unit.
4. Then carefully slide the other side of the unit off one corner at a time while installing castors or legs for each corner. Use packing material for under each corner of the unit before installing a castor or leg.



Removing shipping bolts

INSTALLATION OF CASTORS OR OPTIONAL LEGS

Important Safeguard for installation of leg/castor: Images 1-5 demonstrate procedure.

SECURING CASTORS AND LEGS

To obtain maximum strength and stability of the unit, it is important that you make sure each castor is secure. Optional legs are hand-tightened securely against the lower rail assembly. The bearing race on the castor or the top edge of the leg must make firm contact with the rail.

LEVELING SHIMS

Four leveling shims have been provided for leveling castored units positioned on uneven floors. Shims must be positioned between rail end and bearing race.

- A. Turn the bearing race counter-clockwise until the cabinet is level. Level front to back and side to side. (diagonally)
- B. Install the desired number of shims, making sure the slot of the shim is in contact with the threaded stem of the castor.
- C. If more than one shim is used, turn the slot at a 90° angle so they are not in line.
- D. Turn the bearing race clockwise to tighten and secure the castor by tightening the anchoring bolt with a 3/4 inch open-end wrench or the tool provided.

CAUTION: TO AVOID DAMAGE TO LOWER RAIL ASSEMBLY, SLOWLY RAISE UNIT TO UPRIGHT POSITION.

NOTE: OPEN HOLES LOCATED ON THE CROSS MEMBERS OF THE FRAME RAIL SHOULD BE PLUGGED BEFORE UNIT IS IN USE.



1

Slide packing material under the unit.



2

Anchor castor.

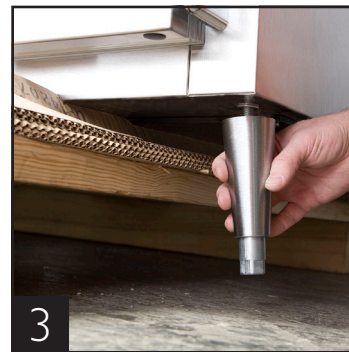

3

Thread leg into cabinet bottom cabinet.

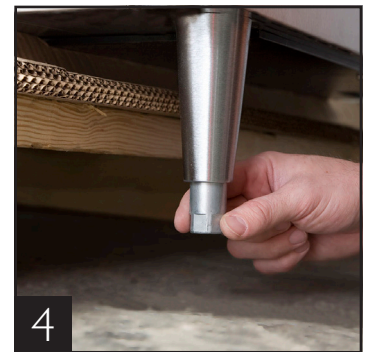

4

The end of the leg is adjustable for easy leveling.

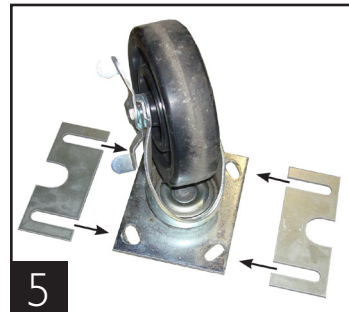

5

Castor with leveling shims.

LEVELING

- A. Proper leveling of your TRUE unit is critical to operating success (for non-mobile models). Effective door operation will be effected by leveling.
- B. The unit should be leveled front to back and side to side with a level.
- C. Free plug and cord from the top of the unit (do not plug in).
- D. The unit should be placed close enough to the electrical supply so that extension cords are never used.

NOTE: If the cabinet has a center leveling screw, castor, or leg, make sure it is adjusted properly so it makes full contact with the floor after the cabinet has been leveled.

WARNING: WARRANTIES ARE VOID IF THE UNIT IS MORE THAN 7 FT. (2.1M) FROM PLUG-IN CONNECTION.

SEALING CABINET TO FLOOR

STEP 1 - Position Cabinet - Allow one inch between the wall and rear of the refrigerator to assure proper ventilation. For freezers 3 inches between the wall and rear of the cabinet will assure proper ventilation.

STEP 2 - Level Cabinet - Cabinet should be level, side to side and front to back. Place a carpenter's level in the interior floor in four places:

- A. Position level in the inside floor of the unit near the doors. (Level should be parallel to cabinet front). Level cabinet.
- B. Position level at the inside rear of cabinet. (Again level should be placed parallel to cabinet back).
- C. Perform similar procedures to steps A & B by placing the level on inside floor (left and right sides - parallel to the depth of the cooler). Level cabinet.

STEP 3 - Draw an outline on the base on the floor.

STEP 4 - Raise and block the front side of the cabinet.

STEP 5 - Apply a bead of "NSF Approved Sealant", (see list below), to floor on half inch inside the outline drawn. The bead must be heavy enough to seal the entire cabinet surface when it is down on the sealant.

STEP 6 - Raise and block the rear of the cabinet

STEP 7 - Apply sealant on floor as outlined in Step 5 on other three sides.

STEP 8 - Examine to see that cabinet is sealed to floor around entire perimeter.

NOTE: Asphalt floors are very susceptible to chemical attack. A layer of tape on the floor prior to applying the sealant will protect the floor.

NSF APPROVED SEALANTS:

1. Minnesota Mining #ECU800 Caulk
2. Minnesota Mining #ECU2185 Caulk
3. Minnesota Mining #ECU1055 Bead
4. Minnesota Mining #ECU1202 Bead
5. Armstrong Cork - Rubber Caulk
6. Products Research Co. #5000 Rubber Caulk
7. G.E. Silicone Sealer
8. Dow Corning Silicone Sealer

ROLL-IN & ROLL-THRU RAMP INSTALLATION

Once the cabinet is in its final location and level the roll-in ramp can be installed. The ramp has three slotted holes in back. These slotted holes slide over three thumb screws located in the front of the cabinet near the floor.

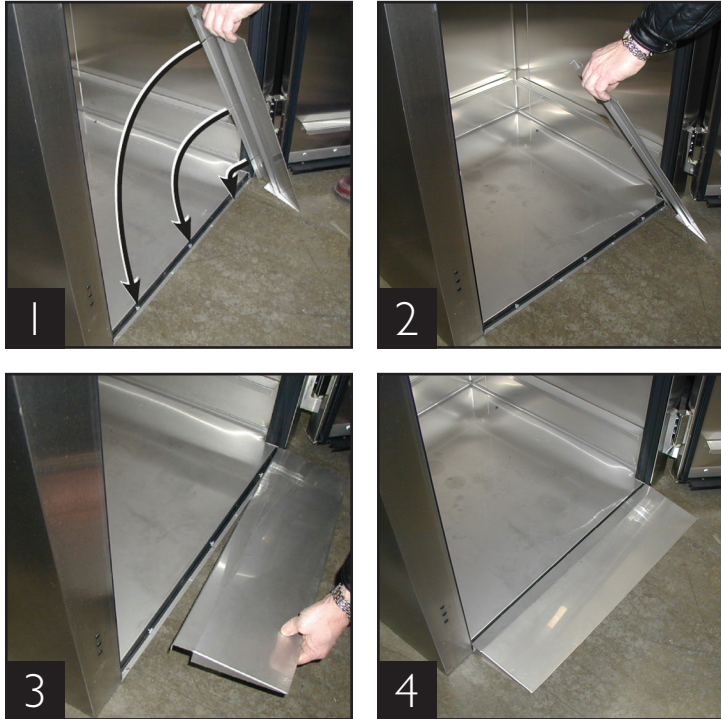

DOOR SWEEP GASKET ADJUSTMENT

To adjust door sweeper gasket, loosen slotted thumbscrews. The gasket can then be moved up or down and side to side. The gasket should make some contact with the ramp when the door is closing. This can be checked by opening up the door 3-4" and allowing the door to close. This process may have to be done several times before securing the sweeper gasket bracket. Once gasket is properly adjusted, tighten slotted thumbscrews. See image 5.



HUMIDIFICATION PROCEDURE

ADJUSTING HUMIDITY

This instruction is TRUE's recommended procedure for providing interior humidity control.

The heated cabinet is designed to provide flexibility in desired interior humidity.

LOW HUMIDITY

- A. Positioned on top of the unit and behind the rainshield is the manual humidity control. To access the humidity control see instruction above to secure rainshield in the open position.
- B. Turn counterclockwise to ventilate cabinet humidity. (See photo below)

HIGH HUMIDITY

- A. When cabinet contents require higher humidity, close the vent shown below.

PART FUNCTION

TRUE has designed this part to assist in preventing overhead moisture from entering into the food zone of the cabinet.

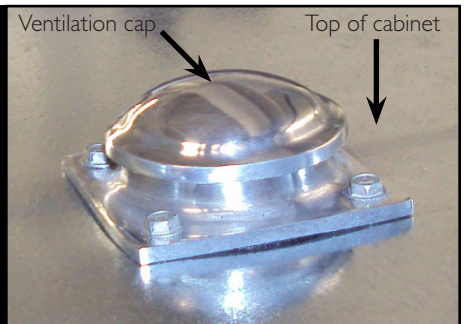

SETUP

STANDARD ACCESSORIES

PILASTER INSTALLATION & OPERATION

TRUE STR, STA, and STG cabinets are available with four different shelving / tray slide options.

Type Kit #1.	Angle Type Tray Slide
Type Kit #2.	Rod Style Tray Slide
Type Kit #3.	Universal Tray Slide
Type Kit #4.	Shelf Standards (shelf clips)

REQUIRED TOOLS:

- Standard Screwdriver (Flathead)
- Rubber / Plastic Mallet
- Tape Measure

INSTALLATION PROCEDURES (WIRE SHELVES):

Wire shelves come with shelf clips (image 1).

Properly insert the shelf clips in the desired height (remember all shelf clips will need to be installed at the same height to keep the shelf level.)

Once the shelves are installed the remaining threaded holes will have thumb screws inserted. These thumb screws are provided in the unit.

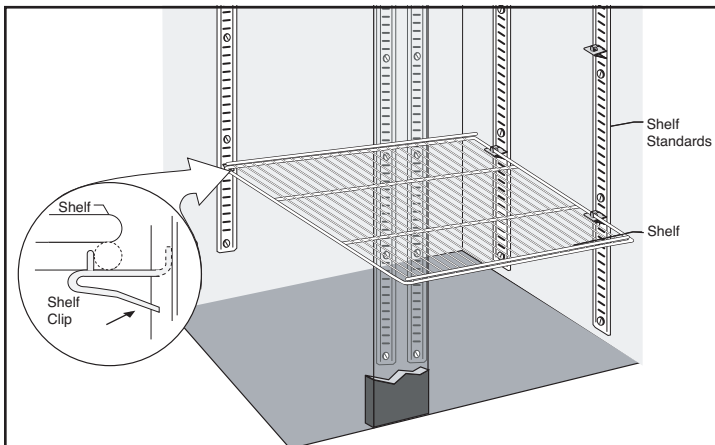

Type Kit #4 (Shelf Standards / Shelf Clips)

WARNING!

Do not use pliers or any crimping tools when installing shelf clips. Altering shelf clips in any way can lead to shelving instability.

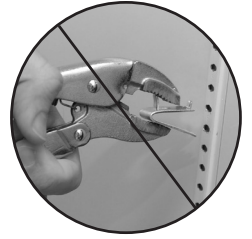

SHELF INSTALLATION:

For Proper Shelf Clip Installation Please Read The Following Instructions.

STEP 1

Install the top tab of the shelf clip into the proper hole. Push up on the bottom of the clip. (See image 1).

STEP 2

Bottom tab of the shelf clip will fit tightly. You may need to squeeze or twist the bottom of the shelf clip to install. (See image 2 & 3).

STEP 3

After installation, the shelf clip will fit snug into the shelf standard. The shelf clip should not be loose or able to wiggle out of the shelf standard.

SHELF INSTALLATION TIPS

1. Install all the shelf clips before installing the shelves.
2. Start at the bottom in terms of shelf installation and work your way up.
3. Always lay the back of each shelf down on the rear clips before the front.

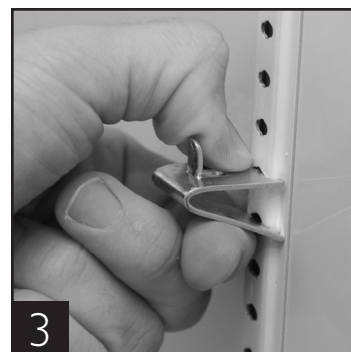
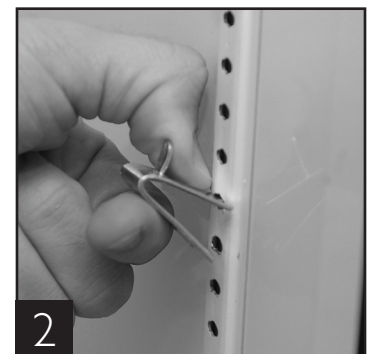
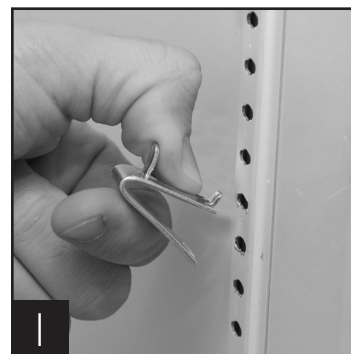

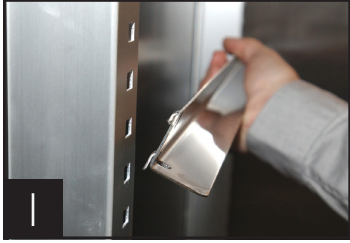

Type Kit #1 (Angle Type Tray Slide)



Type Kit #2 (Rod Style Tray Slide)

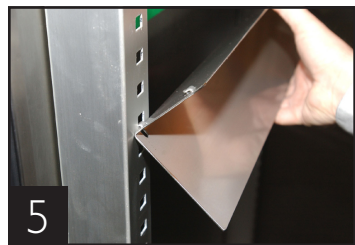

Type Kit #3 (Universal Tray Slide)



CONFIGURATION (PILASTERS):

Each TRUE Specification Series (STR, STA, and STG) is available with two pilaster configurations. Each configuration depends on the end user preference. Multiple door units can have two configurations for each section. See image 7.

INSTALLATION PROCEDURES (PILASTERS):

Install slotted thumb screws into threaded holes along the inside wall of the cabinet.

Slide pilasters into position behind the slotted screws. Leave all of the thumb screws loose for adjustments when installing tray slides.

It is critical to measure from the center of the square hole on the front pilaster to the center hole of the rear pilaster. This measurement should be 24 5/8" (625 mm) (see image 8). Do the same on the opposite side of cabinet for single door. Make sure the measurement of 24 5/8" (625 mm) is the same in the center pilasters in 2 and 3 door units. Tap the tray slides into the Pilasters with a rubber Mallet.

Angle & Rod Type shelving uses a 18 1/8" (460 mm) distance between Pilasters. Universal Tray slides have a 21 1/4" (540 mm) distance between Pilasters. See image 9.

After the pilasters are installed the Universal Tray, Angle Type Tray, and Rod Style Tray Slides will slide into the pilasters. See images 1-6. When disassembling or changing tray slides a rubber mallet may be used to take out the different tray slides. Gently tap on the under side of the tray slide to loosen it from the pilaster.

EXAMPLES OF POSSIBLE CONFIGURATIONS FOR TRAY SLIDES OR SHELVES

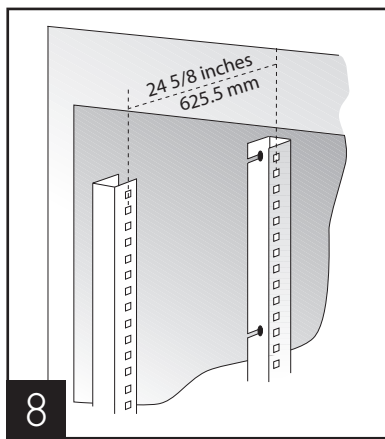
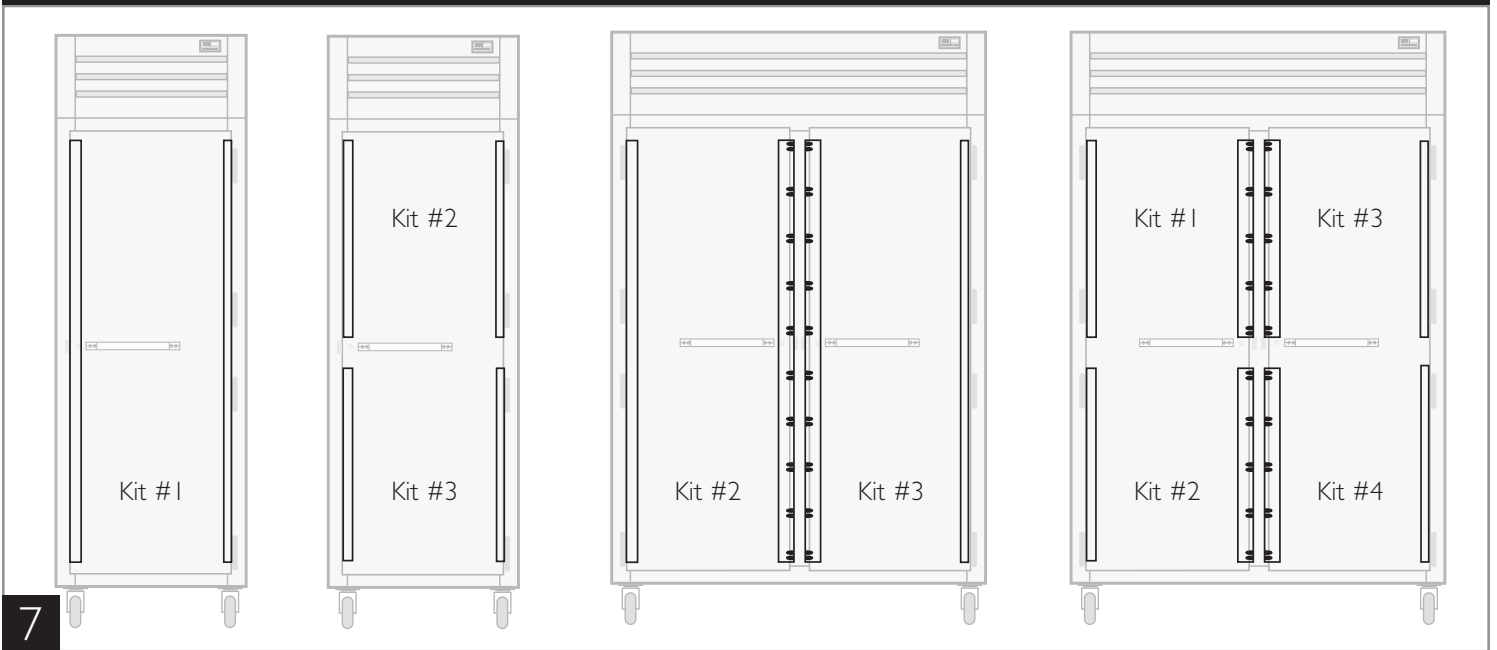

Critical measurement front to rear pilasters

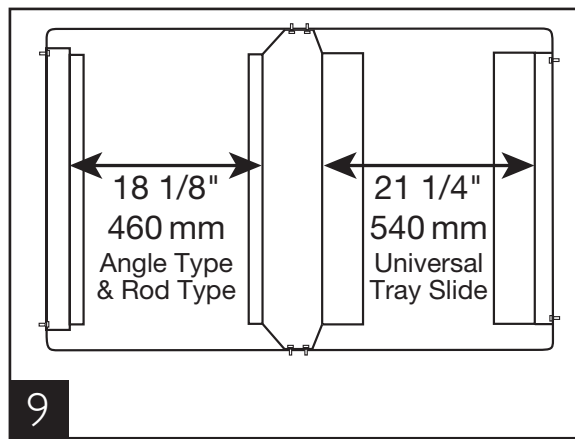

Top view: Critical Measurement side to side



Pilaster installation (side wall of cabinet)



Pilaster installation two and three door models (middle of wall in rear of cabinet)



Pilaster installation (back wall of cabinet for two & three door models)

DOOR OPERATION

DOOR CONFIGURATION:

After installing, cabinet doors can be adjusted for alignment. The hinge on the door and hinge on the cabinet can be adjusted accordingly.

STEP 1

To remove door open at a 90° angle from the cabinet and lift door up and out from the cabinet hinges carefully avoiding rainshield. Rest the door in a safe area.

STEP 2

Remove gray plastic cover from hinge located on the cabinet. (See image 1). Use a standard screw driver and pry out the gray cover. This exposes the three Phillips screws anchoring the hinge to the cabinet. (See image 2). Loosen these three screws but don't remove them. Adjustment can be made slightly up/down and side to side.

STEP 3

The hinge on the cabinet door can also be adjusted. Remove cover from hinge located on the door: Pull on the cover directly out from the door. (See image 3). This exposes the three Phillips screws anchoring the hinge to the door. Loosen these three screws but don't remove them. The hinge can be moved side to side, up and down. (See image 4).

NOTE: WHEN TIGHTENING THE HINGES TO THE CABINET AND DOOR DO NOT APPLY PRESSURE TO THE PHILLIPS SCREWS. CAREFULLY ANCHOR THEM WITHOUT APPLYING EXTREME AMOUNTS OF PRESSURE.

STEP 4

To adjust the lock latch remove two Phillips screws and the latch can be put to the side for later reinstallation. (See image 5). The lock base that anchors the latch can be adjusted simply by loosening the two Phillips screws, but not removing them. Then the lock base can be moved side to side for adjustment. (See image 6). After adjustment is complete tighten the lock base and install the latch back into place.

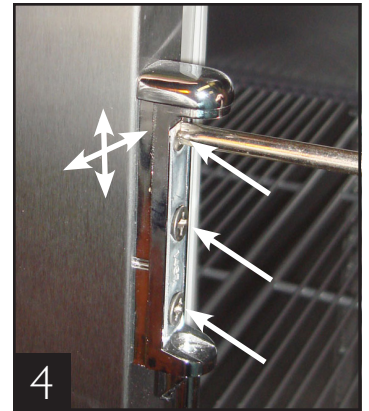
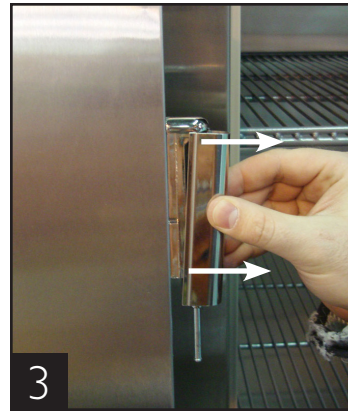
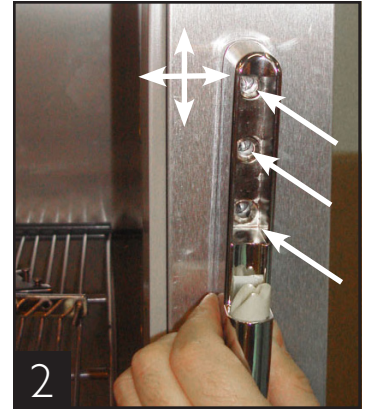

OPERATION

STARTUP

- A. The cabinet is ready to operate. Plug in the unit.
- B. Temperature controls are factory-set to maintain an approximate temperature of 140°F-180°F (60°C-82°C). Allow unit to function several hours, completely heating cabinet before changing the control setting.

Temperature Control Location and Settings.

- LAE temperature control is located on the front of cabinet in louvered grill.
- Mechanical temperature control is located on the front of cabinet in louvered grill.

See website for adjustments, sequence of operation, and more information.

- C. Excessive tampering with the control could lead to service difficulties. Should it ever become necessary to replace temperature control, be sure it is ordered from your TRUE dealer or recommended service agent.
- D. Good air flow in your TRUE unit is critical. Be careful to load product so that it neither presses against the back wall, nor comes within four inches of the evaporator housing. Refrigerated air off the coil must circulate down the back wall.

NOTE: If the unit is disconnected or shut off, wait five minutes before starting again.

RECOMMENDATION - Before loading product we recommend you run your TRUE unit empty for two to three days. This allows you to be sure electrical wiring and installation are correct and no shipping damage has occurred. Remember, our factory warranty does not cover product loss!

MECHANICAL TEMPERATURE CONTROLS

AIR SENSING

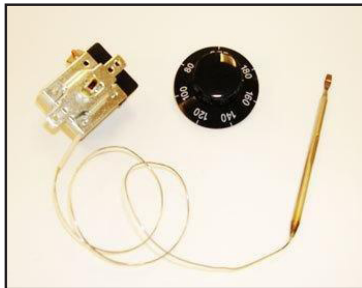

MECHANICAL TEMPERATURE CONTROL GENERAL SEQUENCE OF OPERATION

MECHANICAL CONTROL HEATED CABINET GENERAL SEQUENCE OF OPERATION

1. Cabinet is plugged in.
 - a. Interior lights will illuminate if the rocker switch on the outside panel is in the "ON" position.
2. The temperature control will energize the heat elements if the control is calling for heat.
3. The temperature control will cycle the heating elements on and off.
 - a. The temperature control is sensing the air temperature.
 - b. The temperature control should be set between 140°F-180°F (60°C-82°C).
 - c. The temperature control has an "OFF" position.
 - d. The thermometer is designed to read and display a cabinet temperature not a product temperature. This cabinet temperature may reflect the heating cycle determined by the temperature control. The most accurate temperature on a cabinets operation is to verify the product temperature.

ELECTRONIC TEMPERATURE CONTROLS

LAE ELECTRONIC TEMPERATURE CONTROL GENERAL SEQUENCE OF OPERATION

t1 = supply air / return air* (thermostat) * STA, STG, STM, STR Models.
 t2 = coil / copper line (defrost)
 t3 = return air / supply air* (display)

t3 probe is not installed and / or activated in all applications
 with t3 is not installed and / or activated, the display probe is t1.



LAE MODEL HEATED CABINET ELECTRONIC CONTROL GENERAL SEQUENCE OF OPERATION

1. Cabinet is plugged in.
 - a. Display will illuminate.
2. The LAE control will energize the heat elements if the control is calling for heat.
3. The LAE control will cycle the heating elements on and off determined by the Set-Point and Differential temperatures.
 - a. The Set-Point is the adjustable preprogrammed temperature which de-energizes the heat elements. This is not the programmed cabinet temperature.
 - b. The Differential is the non adjustable preprogrammed temperature that is added to the Set-Point temperature that will re-energize the heat elements.
 - c. The LAE control is designed to read and display a cabinet temperature not a product temperature. This cabinet temperature may reflect the heating cycle of the Set-Point and it's Differential. The most accurate temperature on a cabinets operation is to verify the product temperature.

Example: If the Set-Point is 180°F/82.2°C and the Differential is 1°F/.56°C

$$(\text{Set-Point}) 180^{\circ}\text{F} + 1 (\text{Differential}) = 181^{\circ}\text{F}$$

Or

$$(\text{Set-Point}) 82.2^{\circ}\text{C} + .56 (\text{Differential}) = 82.76^{\circ}\text{C}$$

The heating elements will cycle on 180°F/82.2°C and back off at 181°F/82.76°C

HOW TO DIAGNOSE AN LAE ELECTRONIC CONTROL

Indicator lights for Refrigeration/Heating Mode, Fan Operation, Defrost Mode.

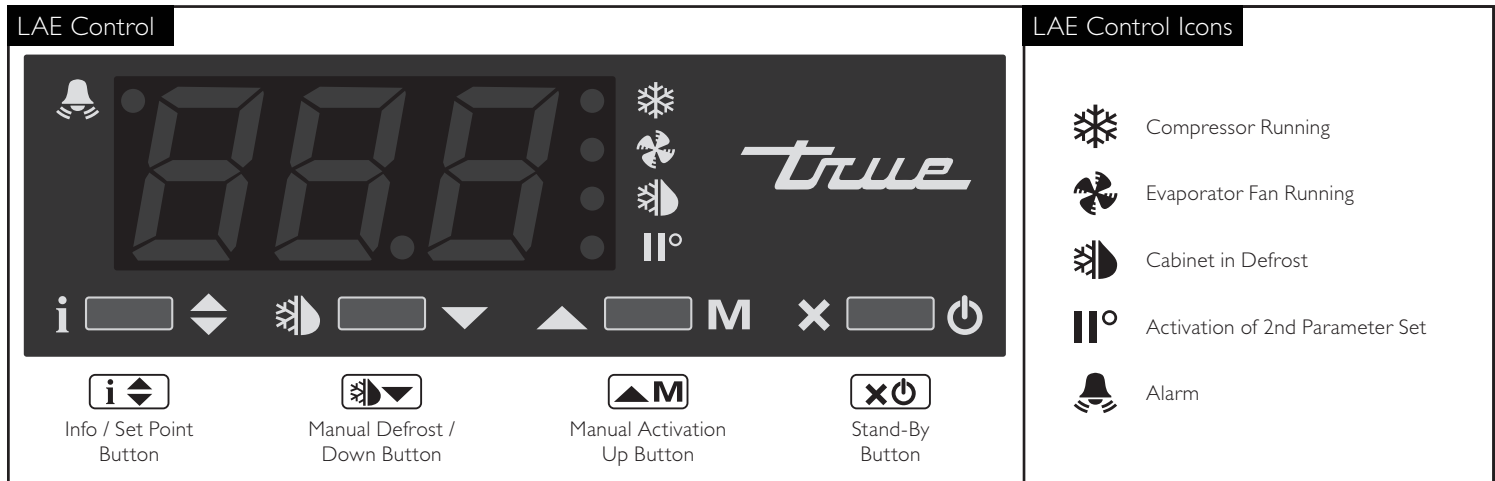

USING THE LAE ELECTRONIC CONTROL



LOCKING AND UNLOCKING THE LAE CONTROLLER:

WHY: Locking of control is necessary to prevent changes to program that may affect cabinet operation.

HOW TO LOCK AND UNLOCK LAE CONTROLLER:

STEP 1 - To change lock setting press and release the Info button . "tl" will appear. See image 1.

STEP 2 - Press the Down button  until "Loc" appears. See image 2.

STEP 3 - While pressing and holding the Info button  press the Up  or Down  button to change the lock settings. If "no" appears, the controller is unlocked. If "yes" appears, the controller is locked. See images 3 and 4.

STEP 4 - Once the lock setting has been set correctly release the info button . Wait 5 seconds for the display to show temperature. See image 5.



Image 3: If "no" appears on screen, the controller is unlocked.



Image 4: If "yes" appears on screen, the controller is locked.



LAE Control



Info / Set Point Button



Manual Defrost / Down Button



Manual Activation Up Button



Stand-By Button

HOW TO TURN OFF THE LAE ELECTRONIC CONTROL:

May need to unlock control.

WHY: Turning off the control will deactivate all electrical components.

CAUTION: Turning off the control will not shut off power to the cabinet. Cabinet must be unplugged prior to any repair.

HOW TO TURN OFF THE LAE ELECTRONIC CONTROL:

STEP 1 - To turn off control, press and hold the Stand-by button  until "OFF" appears. Release Stand-by button. See Image 2.

STEP 2 - To turn on control, repeat prior steps and a temperature will appear.



TURNING THE GLASS DOOR MODEL LIGHTS ON AND OFF:

May need to unlock control.

WHY: Light may be controlled by LAE Controller or interior light switch.

ON Position →



HOW TO TURN THE GLASS DOOR MODEL LIGHT ON AND OFF:

STEP 1 - To control interior / sign lights by the LAE Controller, press and release the Manual Activation button .

STEP 2 - To control interior / sign lights by the interior door switch, depress the rocker switch to the "ON" position. Light switch is located on inside top right of the ceiling.



Solid Door model lights are controlled by a door switch.

LAE Control



Info / Set Point
Button



Manual Defrost /
Down Button



Manual Activation
Up Button



Stand-By
Button

CHANGING THE "SET POINT":



May need to unlock control.

WHY: The set point is the temperature at which the compressor will shut off.

NOTE: The "set point" *IS NOT* the cabinet holding temperature.

HOW TO CHANGE THE "SET POINT":

STEP 1 - To see the set point, press and hold the Info button . See image 1.

STEP 2 - While still holding the Info button , press the Up  or Down  button to change the "set point".

STEP 3 - Once the "set point" has been set correctly release the Info button . The display will show temperature. See image 2.



LAE Controller Parameter Settings for Celsius

For every model / version of the LAE controller,

ALL parameters with a formula shown need to be

converted for Celsius applications.

EXCEPT MODEL: BR1

EXAMPLE:

If current SPL is set for 20 degrees F,
the formula is $(X-32) / 1.8$

$$(20-32) / 1.8 = -6.7 \text{ Celsius}$$

AR2-28	
SCL	1C
SPL	$(X-32) / 1.8$
SPH	$(X-32) / 1.8$
SP	$(X-32) / 1.8$
C-H	
HYS	$(X) / 1.8$
CRT	
CT1	
CT2	
CSD	
DFM	
DFT	
DH1	
DH2	
DH3	
DH4	
DH5	
DH6	
DLI	$(X-32) / 1.8$
DTO	
DTY	
DPD	
DRN	
DDM	
DDY	
FID	
FDD	$(X-32) / 1.8$
FTO	
FCM	
FDT	$(X) / 1.8$
FDH	$(X) / 1.8$
FT1	
FT2	
FT3	
ATM	
ALA	$(X-32) / 1.8$
AHA	$(X-32) / 1.8$
ALR	$(X) / 1.8$
AHR	$(X) / 1.8$
ATI	
ATD	

BIT25	
SPL	$(X-32) / 1.8$
SPH	$(X-32) / 1.8$
SP	$(X-32) / 1.8$
HYS	$(X) / 1.8$
CT1	
CT2	
CSD	
DFM	
DFT	
DFB	
DLI	$(X-32) / 1.8$
DTO	
DTY	
DPD	
DRN	
DDM	
DDY	
FID	
FDD	$(X-32) / 1.8$
FTO	
FCM	
FDT	$(X) / 1.8$
FDH	$(X) / 1.8$
FT1	
FT2	
FT3	
ATM	
ALA	$(X-32) / 1.8$
AHA	$(X-32) / 1.8$
ALR	$(X) / 1.8$
AHR	$(X) / 1.8$
ATI	
ATD	

ADO	
AHM	
AHT	$(X-32) / 1.8$
ACC	
IISL	$(X-32) / 1.8$
IISH	$(X-32) / 1.8$
IISP	$(X-32) / 1.8$
IIHY	$(X) / 1.8$
IIFC	
IIDF	
SB	
DI1	
DI2	
T3M	
OS3	$(X) / 1.8$
PSL	$(X-32) / 1.8$
PSR	$(X-32) / 1.8$
POF	
LSM	
OA1	
OA2	
OS1	$(X) / 1.8$
T2	
OS2	$(X) / 1.8$
TLD	
SCL	1C
SIM	
ADR	

BIT25 Heating	
SPL	$(X-32) / 1.8$
SPH	$(X-32) / 1.8$
SP	$(X-32) / 1.8$
CM	
HYS	$(X) / 1.8$
TON	
TOF	
PB	
IT	
DT	
AR	
CT	
PF	
HSD	
ATM	
ALA	$(X-32) / 1.8$
AHA	$(X-32) / 1.8$
ALR	$(X) / 1.8$
AHR	$(X) / 1.8$
ATD	

ADO	
SB	
DI1	
DI2	
PSL	$(X-32) / 1.8$
PSR	$(X-32) / 1.8$
POF	
DSM	
LSM	
OA1	
OA2	
OS1	$(X) / 1.8$
TLD	
SCL	1C
SIM	
ADR	

MAINTENANCE, CARE, CLEANING

STAINLESS STEEL EQUIPMENT CARE AND CLEANING

CAUTION: Do not use any steel wool, abrasive or chlorine based products to clean stainless steel surfaces.

STAINLESS STEEL OPPONENTS

There are three basic things which can break down your stainless steel's passivity layer and allow corrosion to rear its ugly head.

1. Scratches from wire brushes, scrapers, and steel pads are just a few examples of items that can be abrasive to stainless steel's surface.
2. Deposits left on your stainless steel can leave spots. You may have hard or soft water depending on what part of the country you live in. Hard water can leave spots. Hard water that is heated can leave deposits if left to sit too long. These deposits can cause the passive layer to break down and rust your stainless steel. All deposits left from food prep or service should be removed as soon as possible.
3. Chlorides are present in table salt, food, and water. Household and industrial cleaners are the worst type of chlorides to use.

RECOMMENDED CLEANERS FOR CERTAIN SITUATIONS / ENVIRONMENTS OF STAINLESS STEEL

- A. Soap, ammonia and detergent medallion applied with a cloth or sponge can be used for routine cleaning.
- B. Arcal 20, Lac-O-Nu Ecoshine applied provides barrier film for fingerprints and smears.
- C. Cameo, Talc, Zud First Impression is applied by rubbing in the direction of the polished lines for stubborn stains and discoloring.
- D. Easy-off and De-Grease It oven aid are excellent for removals on all finishes for grease-fatty acids, blood and burnt-on foods.
- E. Any good commercial detergent can be applied with a sponge or cloth to remove grease and oil.
- F. Benefit, Super Sheen, Sheila Shine are good for restoration / passivation.

NOTE: The use of stainless steel cleaners or other such solvents is not recommended on plastic parts. Warm soap and water will suffice.

8 STEPS THAT CAN HELP PREVENT RUST ON STAINLESS STEEL:

1. **USING THE CORRECT CLEANING TOOLS**
Use non-abrasive tools when cleaning your stainless steel products. The stainless steel's passive layer will not be harmed by soft cloths and plastic scouring pads. Step 2 tells you how to find the polishing marks.
2. **CLEANING ALONG THE POLISH LINES**
Polishing lines or "grain" are visible on some stainless steels. Always scrub parallel to visible lines on some stainless steels. Use a plastic scouring pad or soft cloth when you cannot see the grain.
3. **USE ALKALINE, ALKALINE CHLORINATED OR NON-CHLORIDE CONTAINING CLEANERS**
While many traditional cleaners are loaded with chlorides, the industry is providing an ever increasing choice of non-chloride cleaners. If you are not sure of your cleaner's chloride content contact your cleaner supplier. If they tell you that your present cleaner contains chlorides, ask if they have an alternative. Avoid cleaners containing quaternary salts as they can attack stainless steel, causing pitting and rusting.
4. **WATER TREATMENT**
To reduce deposits, soften the hard water when possible. Installation of certain filters can remove corrosive and distasteful elements. Salts in a properly maintained water softener can be to your advantage. Contact a treatment specialist if you are not sure of the proper water treatment.
5. **MAINTAINING THE CLEANLINESS OF YOUR FOOD EQUIPMENT**
Use cleaners at the recommended strength (alkaline chlorinated or non-chloride). Avoid build-up of hard stains by cleaning frequently. When boiling water with your stainless steel equipment, the single most likely cause of damage is chlorides in the water. Heating any cleaners containing chlorides will have the same damaging effects.
6. **RINSE**
When using chlorinated cleaners you must rinse and wipe dry immediately. It is better to wipe standing cleaning agents and water as soon as possible. Allow the stainless steel equipment to air dry. Oxygen helps maintain the passivity film on stainless steel.
7. **HYDROCHLORIC ACID (MURIATIC ACID) SHOULD NEVER BE USED ON STAINLESS STEEL**
8. **REGULARLY RESTORE/PASSIVATE STAINLESS STEEL**

GENERAL MAINTENANCE

RAINSHIELD

When using electrical appliances, basic safety precautions should be followed, including the following:

CAUTION: BEFORE PERFORMING SERVICE OR MAINTENANCE MAKE SURE RAINSHIELD IS SECURED IN OPEN POSITION. USE INSTRUCTIONS AND PHOTOS BELOW TO SECURE RAINSHIELD.

1. Remove thumbscrews on the top of each cabinet end.
2. Lift rainshield (careful not to pull on any wires)
3. Reinstall thumbscrews
 - A. The thumbscrews should be put through rainshield holes and fastened into previous position in cabinet end.

CAUTION: MAKE SURE TOP RAINSHIELD IS CORRECTLY SEATED IN THE OPEN POSITION.



Thumbscrew location

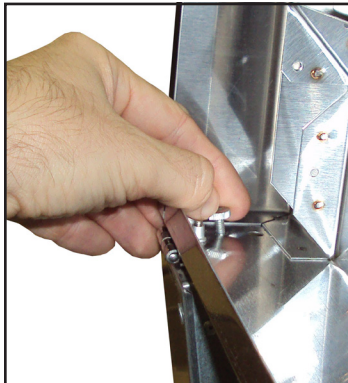

Louver grill in upright position

**FOR ADDITIONAL MAINTENANCE INSTRUCTION,
PLEASE VISIT THE MEDIA CENTER AT
WWW.TRUEMFG.COM**



WARRANTY INFORMATION (U.S.A. & CANADA ONLY!)

THIS WARRANTY ONLY APPLIES TO UNITS SHIPPED FROM TRUE'S MANUFACTURING FACILITIES AFTER SEPTEMBER 1, 2015.

THREE-YEAR PARTS & LABOR WARRANTY

TRUE warrants to the original purchaser of every new TRUE refrigerated unit, the cabinet and all parts thereof, to be free from defects in material or workmanship, under normal and proper use and maintenance service as specified by TRUE and upon proper installation and start-up in accordance with the instruction packet supplied with each TRUE unit. TRUE's obligation under this warranty is limited to a period of three (3) years from the date of original installation or 39 months after shipment date from TRUE, whichever occurs first.

Any part covered under this warranty that are determined by TRUE to have been defective within three (3) years of original installation or thirty-nine (39) months after shipment date from manufacturer, whichever occurs first, is limited to the repair or replacement, including labor charges, of defective parts or assemblies. The labor warranty shall include standard straight time labor charges only and reasonable travel time, as determined by TRUE.

Warranty does not cover standard wear parts which include door gaskets, incandescent bulbs or fluorescent bulbs. Warranty also does not cover issues caused by improper installation or lack of basic preventative maintenance which includes regular cleaning of condenser coils.

ADDITIONAL TWO-YEAR COMPRESSOR WARRANTY

In addition to the Three (3) year warranty stated above, TRUE warrants its hermetically and semi-hermetically sealed compressor to be free from defects in both material and workmanship under normal and proper use and maintenance service for a period of two (2) additional years from the date of original installation but not to exceed five (5) years and three (3) months after shipment from the manufacturer.

Compressors determined by TRUE to have been defective within this extended time period will, at TRUE's option, be either repaired or replaced with a compressor or compressor parts of similar design and capacity.

The two (2) year extended compressor warranty applies only to hermetically and semi-hermetically sealed parts of the compressor and does not apply to any other parts or components, including, but not limited to: cabinet, paint finish, temperature control, refrigerant, metering device, driers, motor starting equipment, fan assembly or any other electrical component, etcetera.

404A/134A/HYDROCARBON COMPRESSOR WARRANTY

The two year compressor warranty detailed above will be voided if the following procedure is not carefully adhered to:

1. This system contains R404A, R134A, or R290 refrigerant and polyol ester lubricant. The polyol ester lubricant has rapid moisture absorbing qualities. If long exposure to the ambient conditions occur, the lubricant must be removed and replaced with new. For oil amounts and specifications please call TRUE technical service department (855-372-1368). Failure to comply with recommended lubricant specification will void the compressor warranty.

2. Drier replacement is very important and must be changed when a system is opened for servicing. An OEM exact replacement should be used. The new drier must also be the same capacity as the drier being replaced.

3. Micron level vacuums must be achieved to insure low moisture levels in the system. 500 microns or lower must be obtained.

WARRANTY CLAIMS

All claims for labor or parts must be made directly through TRUE. All claims should include: model number of the unit, the serial number of the cabinet, proof of purchase, date of installation, and all pertinent information supporting the existence of the alleged defect.

In case of warranty compressor, the compressor model tag must be returned to TRUE along with above listed information.

Any action or breach of these warranty provisions must be commenced within one (1) year after that cause of action has occurred.

WHAT IS NOT COVERED BY THIS WARRANTY

TRUE's sole obligation under this warranty is limited to either repair or replacement of parts, subject to the additional limitations below. This warranty neither assumes nor authorizes any person to assume obligations other than those expressly covered by this warranty.

NO CONSEQUENTIAL DAMAGES. TRUE IS NOT RESPONSIBLE FOR ECONOMIC LOSS; PROFIT LOSS; OR SPECIAL, INDIRECT, OR CONSEQUENTIAL DAMAGES, INCLUDING WITHOUT LIMITATION, LOSSES OR DAMAGES ARISING FROM FOOD OR PRODUCT SPOILAGE CLAIMS WHETHER OR NOT ON ACCOUNT OF REFRIGERATION FAILURE.

WARRANTY IS NOT TRANSFERABLE. This warranty is not assignable and applies only in favor of the original purchaser/user to whom delivered. ANY SUCH ASSIGNMENT OR TRANSFER SHALL VOID THE WARRANTIES HEREIN MADE AND SHALL VOID ALL WARRANTIES, EXPRESS OR IMPLIED, INCLUDING ANY WARRANTY OF MERCHANTABILITY OR FITNESS FOR A PARTICULAR PURPOSE.

IMPROPER USAGE. TRUE ASSUMES NO LIABILITY FOR PARTS OR LABOR COVERAGE FOR COMPONENT FAILURE OR OTHER DAMAGES RESULTING FROM IMPROPER USAGE OR INSTALLATION OR FAILURE TO CLEAN AND/OR MAINTAIN PRODUCT AS SET FORTH IN THE WARRANTY PACKET PROVIDED WITH THE UNIT.

RELOCATION OF CABINET FOR REPAIR. True is not responsible for the cost to move a cabinet for any reason from its position of operation on the customer's premises to make a warranty repair.

NON OEM PARTS. Use of non OEM parts without manufacturer's approval will void cabinet warranty.

ALTERATION, NEGLIGENCE, ABUSE, MISUSE, ACCIDENT, DAMAGE DURING TRANSIT OR INSTALLATION, FIRE, FLOOD, ACTS OF GOD. TRUE is not responsible for the repair or replacement of any parts that TRUE determines have been subjected after the date of manufacture to alteration, neglect, abuse, misuse, accident, damage during transit or installation, fire, flood, or act of God.

IMPROPER ELECTRICAL CONNECTIONS. TRUE IS NOT RESPONSIBLE FOR THE REPAIR OR REPLACEMENT OF FAILED OR DAMAGED COMPONENTS RESULTING FROM INCORRECT SUPPLY VOLTAGE, THE USE OF EXTENSION CORDS, LOW VOLTAGE, OR UNSTABLE SUPPLY VOLTAGE.

NO IMPLIED WARRANTY OF MERCHANTABILITY OR FITNESS FOR A PARTICULAR PURPOSE: THERE ARE NO OTHER WARRANTIES, EXPRESSED, IMPLIED OR STATUTORY, EXCEPT THE THREE (3) YEAR PARTS & LABOR WARRANTY AND THE ADDITIONAL TWO (2) YEAR COMPRESSOR WARRANTY AS DESCRIBED ABOVE. THESE WARRANTIES ARE EXCLUSIVE AND IN LIEU OF ALL OTHER WARRANTIES, INCLUDING IMPLIED WARRANTY AND MERCHANTABILITY OR FITNESS FOR A PARTICULAR PURPOSE. THERE ARE NO WARRANTIES WHICH EXTEND BEYOND THE DESCRIPTION ON THE FACE HEREOF.

OUTSIDE U.S. AND CANADA: This warranty does not apply to, and TRUE is not responsible for, any warranty claims made on products sold or used outside the United States and Canada. This warranty only applies to units shipped from True's manufacturing facilities after September 1, 2015.