



Refrigerated Sushi Showcases

Models RS-CN-0042-S, 0052-S, 0062-S, 0132-S
Items 39553, 39997, 39998, 25828
Instruction Manual



Revised - 08/31/2018

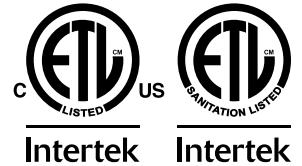

Toll Free: 1-800-465-0234
Fax: 905-607-0234
Email: service@omcan.com
www.omcan.com

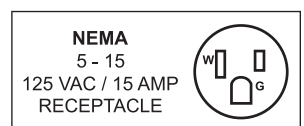

Table of Contents

Model RS-CN-0042-S / Model RS-CN-0052-S
Model RS-CN-0062-S / Model RS-CN-0132-S

Section	Page
General Information -----	3 - 4
Safety and Warranty -----	4 - 6
Technical Specifications -----	6
Operation -----	7 - 8
Maintenance -----	8
Troubleshooting -----	9
Parts Breakdown -----	10 - 12
Electrical Schematics -----	13
Notes -----	14
Warranty Registration -----	15



General Information

Omcan Manufacturing and Distributing Company Inc., Food Machinery of America, Inc. dba Omcan and Omcan Inc. are not responsible for any harm or injury caused due to any person's improper or negligent use of this equipment. The product shall only be operated by someone over the age of 18, of sound mind, and not under the influence of any drugs or alcohol, who has been trained in the correct operation of this machine, and is wearing authorized, proper safety clothing. Any modification to the machine voids any warranty, and may cause harm to individuals using the machine or in the vicinity of the machine while in operation.

CHECK PACKAGE UPON ARRIVAL

Upon receipt of an Omcan shipment please inspect for external damage. If no damage is evident on the external packaging, open carton to ensure all ordered items are within the box, and there is no concealed damage to the machine. If the package has suffered rough handling, bumps or damage (visible or concealed), please note it on the bill of lading before accepting the delivery and contact Omcan within 24 hours, so we may initiate a claim with the carrier. A detailed report on the extent of the damage caused to the machine must be filled out within three days, from the delivery date shown in the shipping documents. Omcan has no recourse for damaged products that were shipped collect or third party.

Before operating any equipment, always read and familiarize yourself with all operation and safety instructions.

Omcan would like to thank you for purchasing this machine. It's of the utmost importance to save these instructions for future reference. Also save the original box and packaging for shipping the equipment if servicing or returning of the machine is required.

Omcan Fabrication et distribution Compañie Limité et Food Machinery d'Amérique, dba Omcan et Omcan Inc. ne sont pas responsables de tout dommage ou blessure causé du fait que toute personne ait utilisé cet équipement de façon irrégulière. Le produit ne doit être exploité que par quelqu'un de plus de 18 ans, saine d'esprit, et pas sous l'influence d'une drogue ou d'alcool, qui a été formé pour utiliser cette machine correctement, et est vêtu de vêtements de sécurité approprié. Toute modification de la machine annule toute garantie, et peut causer un préjudice à des personnes utilisant la machine ou des personnes à proximité de la machine pendant son fonctionnement.

VÉRIFIEZ LE COLIS DÈS RÉCEPTION

Dès réception d'une expédition d'Omcan veuillez inspecter pour dommages externes. Si aucun dommage n'est visible sur l'emballage externe, ouvrez le carton afin de s'assurer que tous les éléments commandés sont dans la boîte, et il n'y a aucun dommage dissimulé à la machine. Si le colis n'a subi aucune mauvaises manipulations, de bosses ou de dommages (visible ou cachée), notez-le sur le bond de livraison avant d'accepter la livraison et contactez Omcan dans les 24 heures qui suivent, pour que nous puissions engager une réclamation auprès du transporteur. Un rapport détaillé sur l'étendue des dommages causés à la machine doit être rempli dans un délai de trois jours, à compter de la date de livraison indiquée dans les documents d'expédition. Omcan n'a aucun droit de recours pour les produits endommagés qui ont été expédiés ou cueilli par un tiers transporteur.

General Information

Avant d'utiliser n'importe quel équipement, toujours lire et vous familiariser avec toutes les opérations et les consignes de sécurité.

Omcan voudrais vous remercier d'avoir choisi cette machine. Il est primordial de conserver ces instructions pour une référence ultérieure. Également conservez la boîte originale et l'emballage pour l'expédition de l'équipement si l'entretien ou le retour de la machine est nécessaire.

Omcan Empresa De Fabricacion Y Distribucion Inc. Y Maquinaria De Alimentos De America, Inc. dba Omcan y Omcan Inc. no son responsables de ningun daño o perjuicio causado por cualquier persona inadecuada o el uso descuidado de este equipo. El producto solo podra ser operado por una persona mayor de 18 años, en su sano juicio y no bajo alguna influencia de droga o alcohol, y que este ha sido entrenado en el correcto funcionamiento de esta máquina, y ésta usando ropa apropiada y autorizada. Cualquier modificación a la máquina anula la garantía y puede causar daños a las personas usando la máquina mientras esta en el funcionamiento.

REVISE EL PAQUETE A SU LLEGADA

Tras la recepcion de un envio Omcan favor inspeccionar daños externos. Si no hay daños evidentes en el empaque exterior, Habra el carton para asegurarse que todos los articulos solicitados estén dentro de la caja y no encuentre daños ocultos en la máquina. Si el paquete ha sufrido un manejo de poco cuidado, golpes o daños (visible o oculto) por favor anote en la factura antes de aceptar la entrega y contacte Omcan dentro de las 24 horas, de modo que podamos iniciar una reclamación con la compañía. Un informe detallado sobre los daños causados a la máquina debe ser llenado en el plazo de tres días, desde la fecha de entrega que se muestra en los documentos de envío. Omcan no tiene ningun recurso por productos dañados que se enviaron a recoger por terceros.

Antes de utilizar cualquier equipo, siempre lea y familiarizarse con todas las instrucciones de funcionamiento y seguridad.

Omcan le gustaría darle las gracias por la compra de esta máquina. Es de la mayor importancia para salvar estas instrucciones para futuras consultas. Además, guarda la caja original y el embalaje para el envío del equipo si servicio técnico o devolución de la máquina que se requiere.

Safety and Warranty

Handle with care	Dry place
Unplug the wall socket first. Never tilt it over 45 degrees when handling.	Always place the refrigerator in a dry location.

Safety and Warranty

<p>Sufficient space The distance from both sides and back of refrigerator to wall or other substance must be no less than 10 cm (4"). The refrigeration capability may decrease if its surrounding space is too small to circulate air.</p>	<p>Well ventilated Always place the refrigerator in an area with proper ventilation. When using for the first time, wait at least 2 hours after handling to start.</p>
<p>Far from heat source Never place the refrigerator under direct sunlight. Never place refrigerator near heat source, as it reduces refrigeration capabilities.</p>	<p>Heavy load Never put any heavy objects on top of the refrigerator.</p>
<p>Do not make holes Never make any holes on the refrigerator. Do not attach any objects onto the refrigerator.</p>	<p>Stable Location Unpack and place the refrigerator on level and stable ground.</p>
<p>Exclusive power socket Normally, the power supply should be 110V, 60 Hz single phase AC with exclusive single phase receptacle.</p>	<p>Do not share the socket Never let the refrigerator share a socket with another appliance. The cable may become hot and this may cause a fire.</p> <p>DO NOT USE EXTENSION CORDS.</p>
<p>Protect cables Never break or damage the cables as this may cause current leakage resulting in a fire.</p>	<p>No water flushing Never spray down refrigerator with pressurized water supply.</p>
<p>Avoid flammable and explosive objects Never put any flammable or explosive items inside the refrigerator such as gasoline or alcohol. Never put any dangerous products in close proximity to the refrigerator.</p>	<p>No spray Do not spray the unit with a flammable substance such as paint. This may result in a fire.</p>
<p>After power break After power break or unplugging the refrigerator, always wait at least 4 minutes before starting the refrigerator again.</p>	<p>Medical Storage No medicine is allowed to be kept inside the refrigerator.</p>

1 YEAR PARTS AND LABOUR WARRANTY

Within the warranty period, contact Omcan Inc. at 1-800-465-0234 to schedule an Omcan authorized service technician to repair the equipment locally.

Unauthorized maintenance will void the warranty. Warranty covers electrical and part failures, not improper use.

Please see <https://omcan.com/disclaimer> for complete info.

Safety and Warranty

WARNING:

The packaging components are classified as normal solid urban waste and can therefore be disposed of without difficulty.

In any case, for suitable recycling, we suggest disposing of the products separately (differentiated waste) according to the current norms.

DO NOT DISCARD ANY PACKAGING MATERIALS IN THE ENVIRONMENT!

WARNING: The unit uses R134a refrigerant. Make sure that all precautions against fire have been taken.

MEANING OF CROSSED OUT WHEELED DUSTBIN

Do not dispose of electrical appliances as unsorted municipal waste, use separate collection facility. Contact your local government for information regarding the collection systems available.



Technical Specifications

Model	RS-CN-0042-S	RS-CN-0052-S	RS-CN-0062-S	RS-CN-0132-S
Volume	42 L / 1.48 Cu. Ft.	52 L / 1.83 Cu. Ft.	62 L / 2.12 Cu. Ft.	132 L / 4.61 Cu. Ft.
Power	160 W			
Consumption	1.98 kilowatts per hour/ 24h			
Temperature	0-12°C / 32-53.6°F			
Electrical	110V/60/1			
Dimensions	50" x 20" x 14" 1270 x 508 x 356mm	56.8" x 20" x 14" 1443 x 508 x 356mm	16.5" x 60.2" x 10.4" 419 x 1529 x 264mm	16.9" x 71" x 11.6" 429 x 1803 x 295mm
Weight	76 lbs. / 34.5 kgs.	80.5 lbs. / 36.5 kgs.	89.3 lbs. / 40.5 kgs.	99.3 lbs. / 45 kgs.
Item Number	39553	39997	39998	25828

NOTE

- The electric circuit diagram and parameters on the product name plate are subject to change without the manufacturer having to change the manual.
- The design might be improved without notice.
- If the power cord is damaged, it must be replaced by the manufacturer, its service agent or a qualified electrician in order to avoid injury.

BEFORE USE

Plug the refrigerator in a 110V~ socket exclusively for the unit. After the refrigerator is running, test the air suction to confirm it is sufficiently cold. Then you may put food inside the unit. Make sure the food product is already cooled before placing it in the display case. The unit should not be used to cool food products.

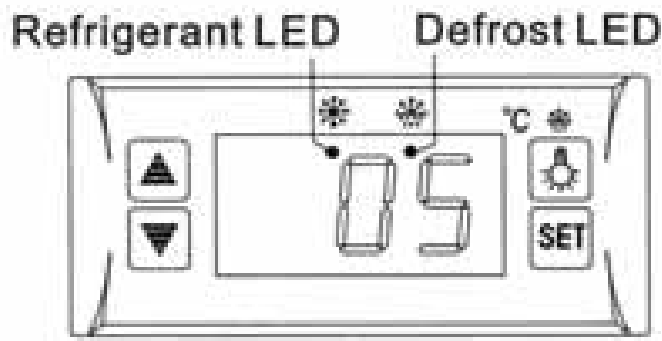

DIGITAL TEMPERATURE CONTROLLER



Features of the Controller:

- It is a mini sized and integrated intelligent controller and applicable to the compressor of one Hp.
- The main functions are: Temperature Display/Temperature Control/Manual, Automatic Defrost by Burning Off/Light Control/Value Storing/Self Testing/Parameter Locking.

Controller Operation:

1. Set Temperature: Press **SET** button, the set temperature is displayed. Press ▲ or ▼ button to modify and store the displayed value. Press **SET** button to exit the adjustment and display the cold-room temperature.
2. If no more button is pressed within 10 seconds, the cold-room temperature will be displayed.
3. Illumination: Press  button, it lights; Press again, it stops. Manual start/stop defrost: Press  button and hold for 6 seconds to defrost or stop defrost.
4. Refrigerant LED: During refrigeration, the LED is on; When the cold room temperature is constant, the LED is off; During the delay start, the LED flashes.
5. Defrost LED: during defrosting, the LED is on; When it stops defrosting, the LED is off, During the delay display of defrost, the LED flashes.

CAUTION

- Reducing the frequency of opening the refrigerator door will keep more cold air inside the refrigerator.
- Do not block air suction or outlet. Air must continue circulating to increase refrigeration capability.
- Do not over fill or over stock the refrigerator, as it will influence the cooling effect. Adjust the rack height for proper food storage.
- Cool hot food down to room temperature before storing it in the refrigerator.
- Try to reduce open times and keep refrigerator cold and closed, if power is ever off. Only allow a skilled service individual with proper tools to repair damaged power cables. Never touch compressor, as it can result in injury.

Operation

- If supply cord is damaged, it must be replaced by the manufacturer, its service agent, or similarly qualified persons in order to avoid a hazard.
- This appliance is not intended for use by persons (including children) with reduced physical, sensory or mental capabilities, or lack of experience and knowledge, unless they have been given supervision or instruction concerning use of the appliance by a person responsible for their safety.
- Children should be supervised to ensure that they do not play with the appliance.

WARNING: Keep ventilation openings, in the appliance enclosure or in the built-in structure, clear of obstruction.

WARNING: Do not use mechanical devices of other means to accelerate the defrosting process, other than those recommended by the manufacturer.

WARNING: Do not damage the refrigerant circuit.

WARNING: Do not use electrical appliances inside the food storage compartments of the appliance, unless they are of the type recommended by the manufacturer.



CAUTION: Risk of fire. The height of the triangle in the symbol shall be at least 15mm.

Maintenance

Keep the refrigerator clean and periodical maintenance is necessary. Always unplug the socket before maintenance. Never use damaged plug or loose socket to prevent from electric shock or short circuit. Never flush the refrigerator. Never use alkali detergent, soap, gasoline, acetone or brush.

1. Clean outside:

Dip soft cloth in neutral detergent (tableware detergent) to clean the outside of the refrigerator and then wipe it with dry soft cloth.

2. Clean inside:

Take rack out for cleaning with water. Use soft cloth to wipe the box.

3. Shut down refrigerator for a long time:

Take all food out and unplug the wall socket. Clean both inside and outside of the refrigerator thoroughly and open the door for sufficient dry. The glass breaks easily. Keep the glass far from children.

4. Replacement of lamp in the light box:

If the LED lamp is damaged, it must be replaced by the manufacturer, or its service agent.

Troubleshooting

Trouble	Cause	Remedy
No refrigeration.	Is the plug in the socket correctly?	Check the plug.
	Is the fuse broken?	Check fuse and replace if needed.
	Is there no power from the socket?	Plug another unit into the socket to check if it works.
Unsatisfactory refrigeration.	Is it in direct sunlight or near a heat source?	Move away from the heat source.
	Is the surrounding area bad for ventilation?	Move to an area with improved ventilation.
	Does the door close correctly? Is the door left open?	Check the door.
	Is the unit too full?	Remove some food.
	Is the temperature controller correct?	Check the controller.
Too much noise.	The fridge is not sitting level.	Move to a flat surface.
	The fridge is vibrating off something else.	Move the unit so it is not touching anything.
	There is a loose part in the refrigerator.	Check the interior for loose items.
Contact Omcan at 1-800-465-0234 for help if simple troubleshooting does not solve the problems.		

The following situations are not problems:

1. The murmur of water is heard when the refrigerator is working. This is normal as the coolant is circulating in the system.
2. Condensation may be found on the outside of the refrigerator. This is not a problem, this is caused by high humidity. Simply use a cloth to wipe it.

REFERENCE

Item Number	Model Number	Description	Manufacturer Model Number
39553	RS-CN-0042-S	Refrigerated Showcase Sushi 42 L / 1.5 Cu. Ft. 110V/60/1 CE cETLus ETL Sanitation	RTS-42L
39997	RS-CN-0052-S	Refrigerated Showcase Sushi 52 L / 1.8 Cu. Ft. 110V/60/1 CE cETLus ETL Sanitation	RTS-52L
39998	RS-CN-0062-S	Refrigerated Showcase Sushi 62 L / 2.1 Cu. Ft. 110V/60/1 CE cETLus ETL Sanitation	RTS-62L
25828	RS-CN-0132-S	Refrigerated Showcase Sushi 132 L / 4.7 Cu. Ft. 110V/60/1 CE cETLus ETL Sanitation	RTS-132L

Parts Breakdown

Model RS-CN-0042-S 39553

Model RS-CN-0052-S 39997

Model RS-CN-0062-S 39998

Model RS-CN-0132-S 25828

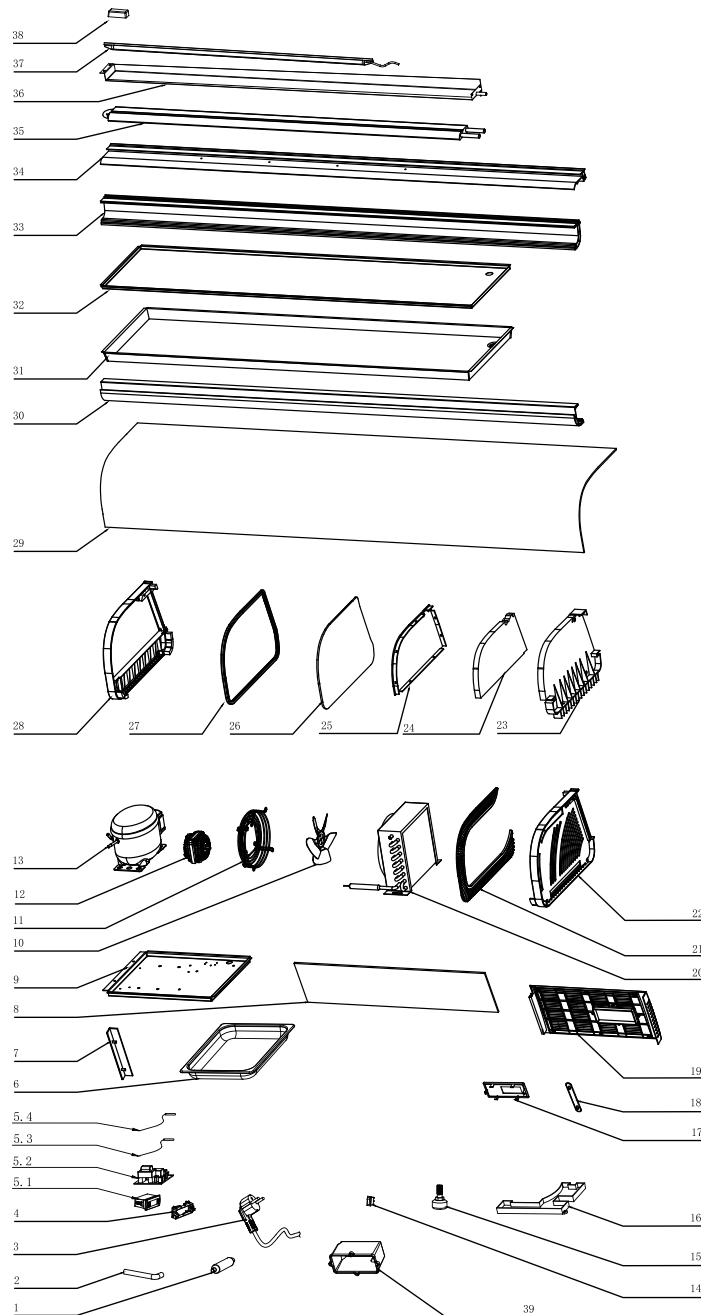



Parts Breakdown

Model RS-CN-0042-S 39553

Item No.	Description	Position	Item No.	Description	Position	Item No.	Description	Position
60144	Dry Filter for RTS-42L	1	30597	Switch for RTS-42L	14	67366	Glass Silica Ring for RTS-42L	27
60105	Water Discharge Pipe for RTS-42L	2	60181	Adjustable Feet for RTS-42L	15	67367	Bracing Piece of Rack for RTS-42L	28
30621	Power Cord for RTS-42L	3	60139	Water Receiver for RTS-42L	16	70443	Curved Front Glass for RTS-42L	29
60125	Digital Controller Holder for RTS-42L	4	67357	Switch Panel for RTS-42L	17	67368	Front Pillar for RTS-42L	30
67773	Digital Controller Complete for RTS-42L	5	60088	Handle for RTS-42L	18	60104	Foam Material for RTS-42L	31
60178	1/2 GN Pan for RTS-42L	6	67358	Rear Plastic Panel for RTS-42L	19	60106	Bottom Panel for RTS-42L	32
67354	Finger Clamp of Glass for RTS-42L	7	67359	Condenser for RTS-42L	20	67369	Rear Pillar for RTS-42L	33
70422	Door Glass for RTS-42L	8	67360	Decorating Plate for RTS-42L	21	67370	Upper Pillar for RTS-42L	34
67355	Bottom Panel of Compressor for RTS-42L	9	67361	Left Plastic Panel for RTS-42L	22	60093	Top Evaporator for RTS-42L	35
60640	Fan Blade for RTS-42L	10	67362	Middle Separator for RTS-42L	23	67371	Top Water Tray for RTS-42L	36
67356	Fan Motor Cover for RTS-42L	11	67363	Foam of Middle Separator for RTS-42L	24	67372	LED Lights for RTS-42L	37
71522	Evaporator Fan Motor for RTS-42L	12	67364	Cover of Middle Separator for RTS-42L	25	67373	LED Power for RTS-42L	38
30615	Compressor for RTS-42L	13	67365	Side Glass for RTS-42L	26	67374	Insulated Panel for RTS-42L	39

Model RS-CN-0052-S 39997

Item No.	Description	Position	Item No.	Description	Position	Item No.	Description	Position
60144	Dry Filter for RTS-52L	1	30597	Switch for RTS-52L	14	67366	Glass Silica Ring for RTS-52L	27
60105	Water Discharge Pipe for RTS-52L	2	60181	Adjustable Feet for RTS-52L	15	67367	Bracing Piece of Rack for RTS-52L	28
30621	Power Cord for RTS-52L	3	60139	Water Receiver for RTS-52L	16	60353	Curved Glass for RTS-52L	29
60125	Digital Controller Holder for RTS-52L	4	67357	Switch Panel for RTS-52L	17	67376	Front Pillar for RTS-52L	30
67773	Digital Controller Complete for RTS-52L	5	60088	Handle for RTS-52L	18	60153	Foam Material for RTS-52L	31
60178	1/2 GN Pan for RTS-52L	6	67358	Rear Plastic Panel for RTS-52L	19	60154	Bottom Panel for RTS-52L	32
67354	Finger Clamp of Glass for RTS-52L	7	67359	Condenser for RTS-52L	20	67377	Rear Pillar for RTS-52L	33
67375	Door Glass for RTS-52L	8	67360	Decorating Plate for RTS-52L	21	67378	Upper Pillar for RTS-52L	34
67355	Bottom Panel of Compressor for RTS-52L	9	67361	Left Plastic Panel for RTS-52L	22	67379	Top Evaporator for RTS-52L	35
60640	Fan Blade for RTS-52L	10	67362	Middle Separator for RTS-52L	23	67380	Top Water Tray for RTS-52L	36
67356	Fan Motor Cover for RTS-52L	11	67363	Foam of Middle Separator for RTS-52L	24	67372	LED Lights for RTS-52L	37
71522	Evaporator Fan Motor for RTS-52L	12	67364	Cover of Middle Separator for RTS-52L	25	67373	LED Power for RTS-52L	38
30615	Compressor for RTS-52L	13	67365	Side Glass for RTS-52L	26	67374	Insulated Panel for RTS-52L	39

Parts Breakdown

Model RS-CN-0062-S 39998

Item No.	Description	Position	Item No.	Description	Position	Item No.	Description	Position
60144	Dry Filter for RTS-62L	1	30597	Switch for RTS-62L	14	67366	Glass Silica Ring for RTS-62L	27
60105	Water Discharge Pipe for RTS-62L	2	60181	Adjustable Feet for RTS-62L	15	67367	Bracing Piece of Rack for RTS-62L	28
30621	Power Cord for RTS-62L	3	60139	Water Receiver for RTS-62L	16	60354	Curved Glass for RTS-62L	29
60125	Digital Controller Holder for RTS-62L	4	67357	Switch Panel for RTS-62L	17	67381	Front Pillar for RTS-62L	30
67773	Digital Controller Complete for RTS-62L	5	60088	Handle for RTS-62L	18	60166	Foam Material for RTS-62L	31
60178	1/2 GN Pan for RTS-62L	6	67358	Rear Plastic Panel for RTS-62L	19	60167	Bottom Panel for RTS-62L	32
67354	Finger Clamp of Glass for RTS-62L	7	67359	Condenser for RTS-62L	20	67382	Rear Pillar for RTS-62L	33
65422	Door Glass for RTS-62L	8	67360	Decorating Plate for RTS-62L	21	67383	Upper Pillar for RTS-62L	34
67355	Bottom Panel of Compressor for RTS-62L	9	67361	Left Plastic Panel for RTS-62L	22	60163	Top Evaporator for RTS-62L	35
60640	Fan Blade for RTS-62L	10	67362	Middle Separator for RTS-62L	23	67384	Top Water Tray for RTS-62L	36
67356	Fan Motor Cover for RTS-62L	11	67363	Foam of Middle Separator for RTS-62L	24	67385	LED Lights for RTS-62L	37
71522	Evaporator Fan Motor for RTS-62L	12	67364	Cover of Middle Separator for RTS-62L	25	67373	LED Power for RTS-62L	38
30615	Compressor for RTS-62L	13	67365	Side Glass for RTS-62L	26	67374	Insulated Panel for RTS-62L	39

Model RS-CN-0132-S 25828

Item No.	Description	Position	Item No.	Description	Position	Item No.	Description	Position
60144	Dry Filter for RTS-132L	1	30597	Switch for RTS-132L	14	67366	Glass Silica Ring for RTS-132L	27
60105	Water Discharge Pipe for RTS-132L	2	60181	Adjustable Feet for RTS-132L	15	67367	Bracing Piece of Rack for RTS-132L	28
30621	Power Cord for RTS-132L	3	67387	Water Tray for RTS-132L	16	67389	Curved Front Glass for RTS-132L	29
60125	Digital Controller Holder for RTS-132L	4	67388	Switch Panel for RTS-132L	17	67390	Front Pillar for RTS-132L	30
67773	Digital Controller Complete for RTS-132L	5	60088	Handle for RTS-132L	18	60179	Foam Material for RTS-132L	31
60178	1/2 GN Pan for RTS-132L	6	67358	Rear Plastic Panel for RTS-132L	19	60180	Bottom Panel for RTS-132L	32
67354	Finger Clamp of Glass for RTS-132L	7	67359	Condenser for RTS-132L	20	67391	Rear Pillar for RTS-132L	33
67386	Door Glass for RTS-132L	8	67360	Decorating Plate for RTS-132L	21	67392	Upper Pillar for RTS-132L	34
67355	Bottom Panel of Compressor for RTS-132L	9	67361	Left Plastic Panel for RTS-132L	22	60175	Top Evaporator for RTS-132L	35
60640	Fan Blade for RTS-132L	10	67362	Middle Separator for RTS-132L	23	67393	Top Water Tray for RTS-132L	36
67356	Fan Motor Cover for RTS-132L	11	67363	Foam of Middle Separator for RTS-132L	24	67394	LED Lights for RTS-132L	37
71522	Evaporator Fan Motor for RTS-132L	12	67364	Cover of Middle Separator for RTS-132L	25	67373	LED Power for RTS-132L	38
30615	Compressor for RTS-132L	13	67365	Side Glass for RTS-132L	26	67374	Insulated Panel for RTS-132L	39

Electrical Schematics

Model RS-CN-0042-S 39553

Model RS-CN-0052-S 39997

Model RS-CN-0062-S 39998

Model RS-CN-0132-S 25828

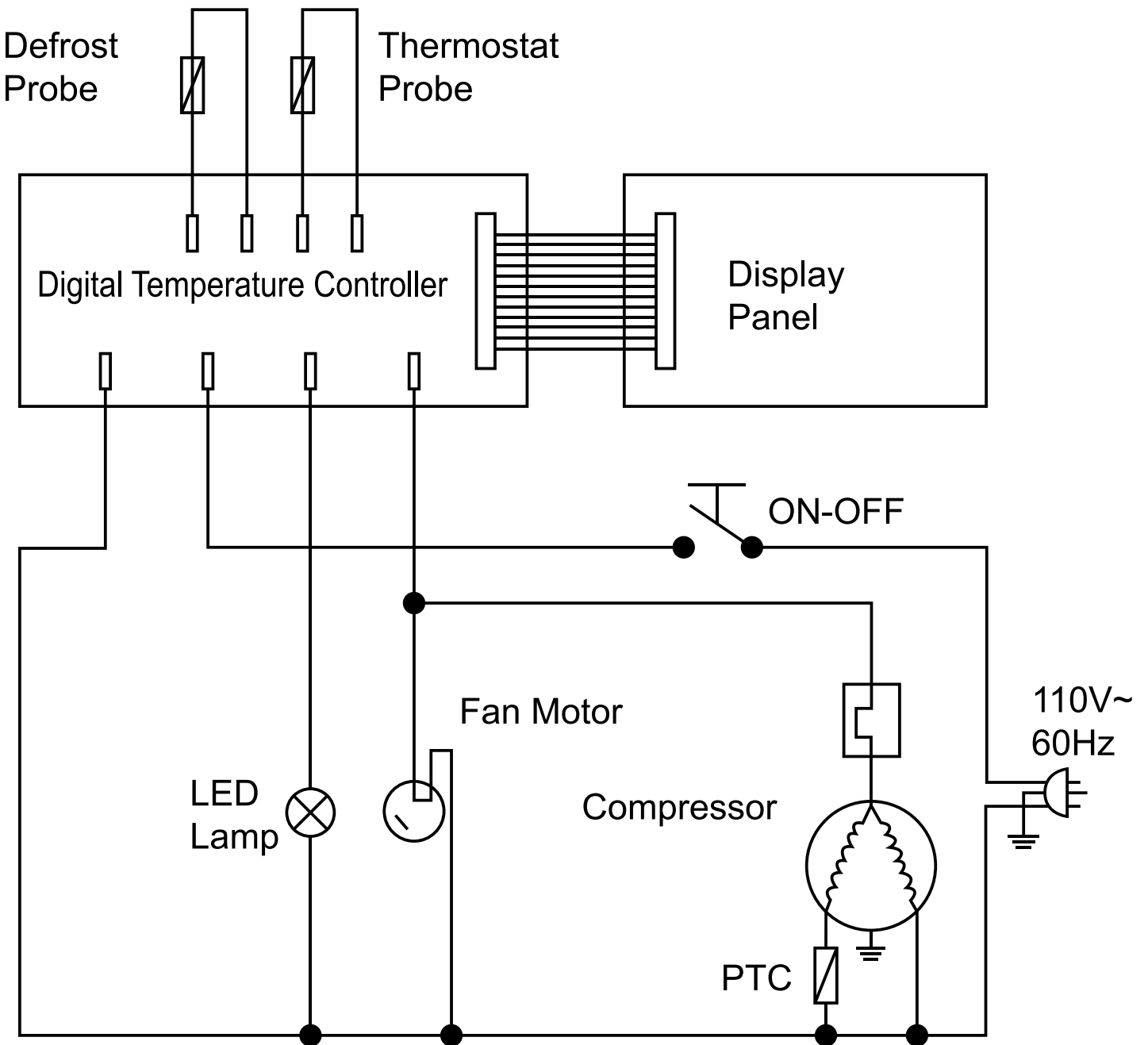

Notes



Warranty Registration

Thank you for purchasing an Omcan product. To register your warranty for this product, complete the information below, tear off the card at the perforation and then send to the address specified below. You can also register online by visiting:

Merci d'avoir acheté un produit Omcan. Pour enregistrer votre garantie pour ce produit, complétez les informations ci-dessous, détachez la carte au niveau de la perforation, puis l'envoyer à l'adresse spécifiée ci-dessous. Vous pouvez également vous inscrire en ligne en visitant:

Gracias por comprar un producto Omcan usted. Para registrar su garantía para este producto, complete la información a continuación, cortar la tarjeta en la perforación y luego enviarlo a la dirección indicada a continuación. También puede registrarse en línea en:

www.omcan.com/warrantyregistration.html

For mailing in Canada

Pour postale au Canada

Por correo en Canadá

For mailing in the US

Pour diffusion aux États-Unis

Por correo en los EE.UU.

OMCAN

PRODUCT WARRANTY REGISTRATION

3115 Pepper Mill Court,

Mississauga, Ontario

Canada, L5L 4X5

OMCAN

PRODUCT WARRANTY REGISTRATION

4450 Witmer Industrial Estates, Unit 4,

Niagara Falls, New York

USA, 14305

or email to: service@omcan.com



Purchaser's Information

Name: _____

Company Name: _____

Address: _____

Telephone: _____

City: _____ Province or State: _____ Postal or Zip: _____

Email Address: _____

Country: _____

Type of Company:

Restaurant Bakery Deli

Butcher Supermarket Caterer

Institution (*specify*): _____

Other (*specify*): _____

Dealer from which Purchased: _____

Dealer City: _____ Dealer Province or State: _____

Invoice: _____

Model Name: _____ Model Number: _____

Serial Number: _____

Machine Description: _____

Date of Purchase (MM/DD/YYYY): _____

Date of Installation (MM/DD/YYYY): _____

Would you like to extend the warranty? Yes No

Thank you for choosing Omcan | Merci d'avoir choisi Omcan | Gracias por elegir Omcan



Since 1951 Omcan has grown to become a leading distributor of equipment and supplies to the North American food service industry. Our success over these many years can be attributed to our commitment to strengthen and develop new and existing relationships with our valued customers and manufacturers. Today with partners in North America, Europe, Asia and South America, we continually work to improve and grow the company. We strive to offer customers exceptional value through our qualified local sales and service representatives who provide convenient access to over 5,000 globally sourced products.

Depuis 1951 Omcan a grandi pour devenir un des “leaders” de la distribution des équipements et matériel pour l’industrie des services alimentaires en Amérique du Nord. Notre succès au cours de ces nombreuses années peut être attribué à notre engagement à renforcer et à développer de nouvelles et existantes relations avec nos clients et les fabricants de valeur. Aujourd’hui avec des partenaires en Amérique du Nord, Europe, Asie et Amérique du Sud, nous travaillons continuellement à améliorer et développer l’entreprise. Nous nous efforçons d’offrir à nos clients une valeur exceptionnelle grâce à nos ventes locales qualifiées et des représentants de service qui offrent un accès facile à plus de 5000 produits provenant du monde entier.

Desde 1951 Omcan ha crecido hasta convertirse en un líder en la distribución de equipos y suministros de alimentos en América del Norte industria de servicios. Nuestro éxito en estos años se puede atribuir a nuestro compromiso de fortalecer y desarrollar nuevas relaciones existentes con nuestros valiosos clientes y fabricantes. Hoy con socios de América del Norte, Europa, Asia y América del Sur, que trabajan continuamente para mejorar y crecer la empresa. Nos esforzamos por ofrecer a nuestros clientes valor excepcional a través de nuestro local de ventas y representantes de los servicios que proporcionan un fácil acceso a más de 5,000 productos con origen a nivel mundial.

