

PROJECT: \_\_\_\_\_  
 LOCATION: \_\_\_\_\_  
 ITEM#: \_\_\_\_\_  
 QUANTITY: \_\_\_\_\_



# FRYERS

- Robertshaw® brand electro-mechanical thermostat for adjusting temperatures within a range of 200°F to 400°F
- 34,000 BTU (natural gas) and 30,000 BTU (LP) per burner
- Beautiful ergonomic design and easy to clean
- All stainless steel tank & cabinetry
- Removable basket hanger for cleaning purposes
- Manual pilot ignition
- Auto reset high limit control for high temperatures
- Cooling zone inside the fryer tank
- Twin nickel chrome plated wire mesh baskets with blue plastic coated handles
- Built in flue deflector
- Full port drain within valve
- (4) adjustable stainless steel legs
- Comes in standard as natural gas or L.P
- Accessory: optional casters upon request
- Migali Industries® Protection Plan: 1 Year Parts & Labor Warranty, 5 Years Oil Tank Warranty

| MODEL               | BURNERS | VOLUME | TOTAL BTU         | PER BTU (BTU/H) NATURAL GAS / LP | IN TAKE TUBE PRESSURE (W.C.) NATURAL GAS / LP | NOZZLE NO. NATURAL GAS / LP | IGNITION | VALVE TYPE                         | THERMOSTAT TEMP LIMIT | TEMP LIMIT | EXTERIOR DIMENSIONS W X D X H | PACKAGED DIMENSIONS W X D X H | WEIGHT   | PACKAGED WEIGHT |
|---------------------|---------|--------|-------------------|----------------------------------|-----------------------------------------------|-----------------------------|----------|------------------------------------|-----------------------|------------|-------------------------------|-------------------------------|----------|-----------------|
| C-F40-NG / C-F40-LP | 3       | 40 lbs | 102,000 / 90,000  | 34,000 / 30,000                  | 4 / 10                                        | #36 / #52                   | Manual   | Often open flame, flame protection | 400° F                | 450° F     | 15.6" x 30.1" x 44.4"         | 17.7" x 33.5" x 37.9"         | 131 lbs. | 160 lbs.        |
| C-F50-NG / C-F50-LP | 4       | 50 lbs | 136,000 / 120,000 | 34,000 / 30,000                  | 4 / 10                                        | #36 / #53                   | Manual   | Often open flame, flame protection | 400° F                | 450° F     | 15.6" x 30.1" x 44.4"         | 17.7" x 33.5" x 37.9"         | 144 lbs. | 171 lbs.        |
| C-F75-NG / C-F75-LP | 5       | 75 lbs | 170,000 / 150,000 | 34,000 / 30,000                  | 4 / 10                                        | #36 / #54                   | Manual   | Often open flame, flame protection | 400° F                | 450° F     | 21.1" x 30.1" x 44.4"         | 23.2" x 33.5" x 37.9"         | 168 lbs. | 200 lbs.        |

Gas Connection: 3/4" NPT on the right  
 Clearance for combustible work area: 6" rear & 15" sides  
 Altitudes over 2,000 feet may need high altitude orifice adjustments to deliver BTU output listed

\* MIGALI® RESERVES THE RIGHT TO CHANGE SPECIFICATIONS WITHOUT NOTICE



TOLL FREE: 800.852.5292  
 WEB: www.migali.com



Conforms to ANSI STD 283, 116-2009 (2011), NSF/ANSI STD 4 & CSA STD 1-06-2009(2011)

# DIMENSIONAL DRAWINGS

C-F40

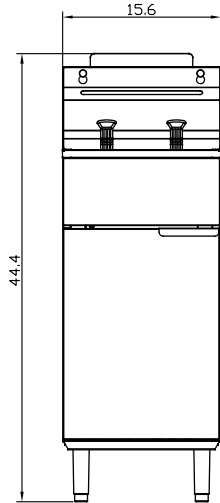

C-F50

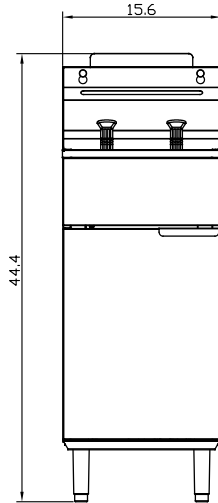

C-F75

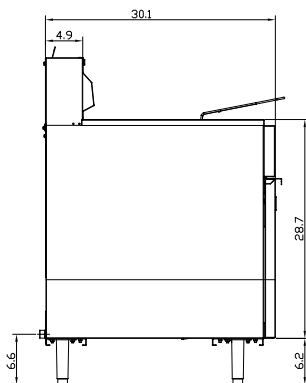
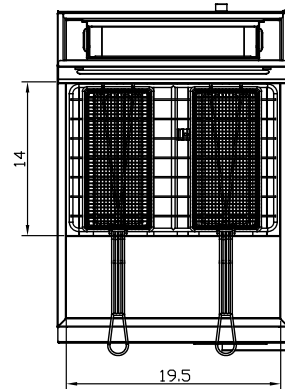
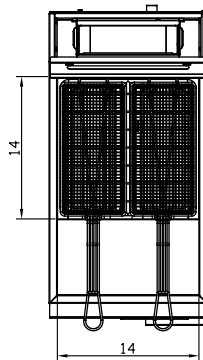
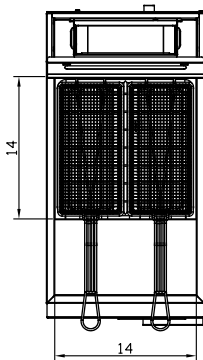
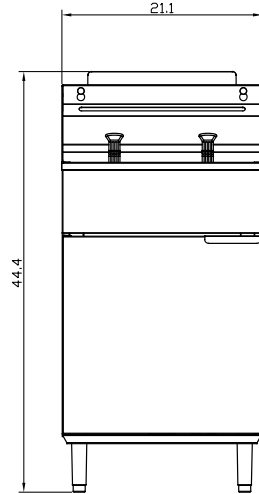

SIDE VIEW



MIGALI® REMAINS AN AMERICAN FAMILY COMPANY SINCE 1955