

INSTALLATION MANUAL FOR GDM FREEZER / REFRIGERATOR (SWING AND SLIDE DOOR)

TABLE OF CONTENTS

► Safety Information

Safety Precautions	1
GDM Do's and Don'ts	2
Proper Disposal	3
Connecting Electricity	4
Adapter Plugs	4

► Installation / Operation Instructions

Ownership	5
Required Tools	5
Uncrating	5
Leveling Cabinet	6
Installation of Optional Leg/Castors	7
Installing GDM-10 & GDM-12	8
Slide Door Operation Instructions	9
Wire Gauge Chart	10
Sealing Cabinet to Floor & Electrical Inst.	11
Start-up	12
LAE Freezer Temperature Control	13-21
Temperature Control Adjustment	22
Shelving Installation/Operation & Light Switches	23
Installing Trueflex Bottle Organizers	24
Grasslin Defrost Timer (Freezer Units Only)	25
Field Troubleshooting (Freezer Units Only)	26-27
Light Cover Install for GDM-10F & GDM-12F	28

► Maintenance, Care & Cleaning

Cleaning Condenser Coil	29-30
Stainless Steel Equipment Care & Cleaning	31-32
Light Bulb Replacement	32
Warranty (U.S.A. & CANADA ONLY!)	33

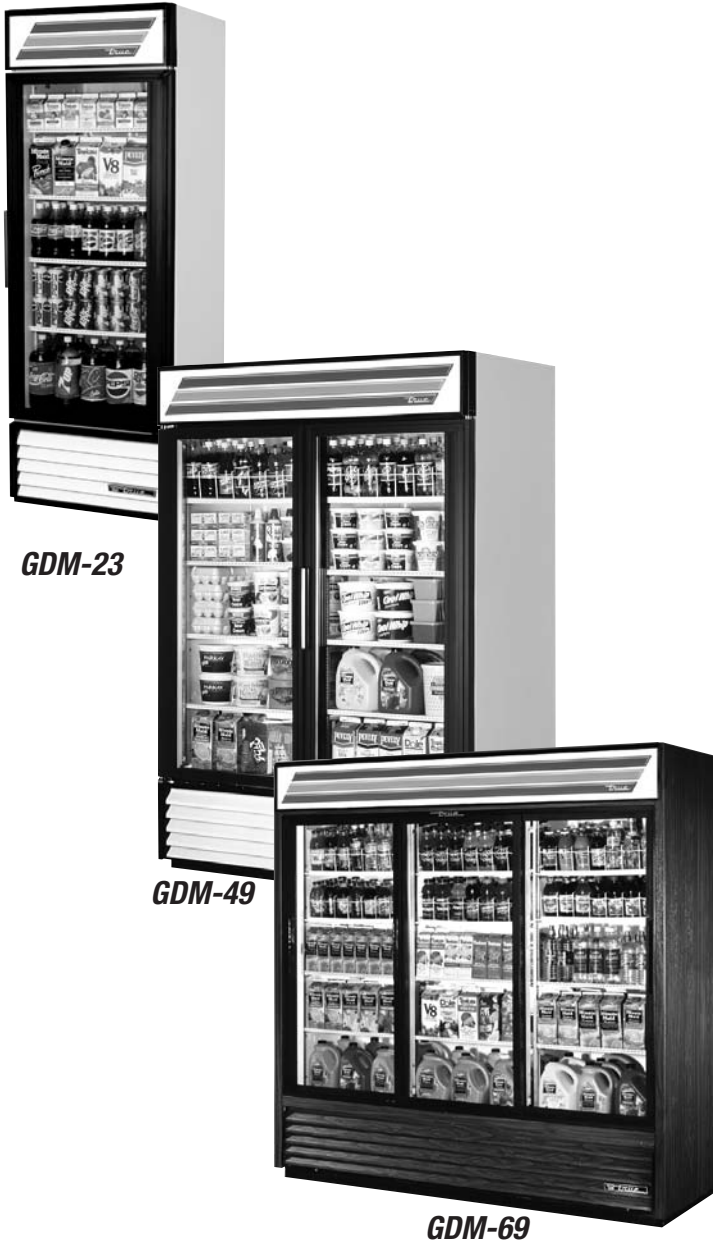

CONGRATULATIONS!

You have just purchased the finest commercial refrigerator available. You can expect many years of trouble-free operation.

GDM® (GLASS DOOR MERCHANDISERS) FREEZER / REFRIGERATOR SWING & SLIDE DOOR

GDM® is a trademark of True Manufacturing Company.

..... www.truemfg.com

NOTICE TO CUSTOMER:



**Loss Or Spoilage Of Products
In Your Refrigerator/Freezer
Is NOT Covered By Warranty.
In Addition To Following
Recommended Installation
Procedures You Must Run
The Refrigerator/Freezer
24 Hours Prior To Usage.**

True Manufacturing Company, Inc.

SAFETY INFORMATION

How to Maintain Your Refrigerator to Receive the Most Efficient and Successful Operation

You have selected one of the finest commercial refrigeration units made. It is manufactured under strict quality controls with only the best quality materials available. Your TRUE cooler when properly maintained will give you many years of trouble-free service.

WARNING!

Use this appliance for its intended purpose as described in this Owner Manual.

This cabinet contains fluorinated greenhouse gas covered by the Kyoto Protocol (please refer to cabinet's inner label for type and volume, GWP of 134a= 1,300. R404a= 3,800).

SAFETY PRECAUTIONS

When using electrical appliances, basic safety precautions should be followed, including the following:

- This refrigerator must be properly installed and located in accordance with the Installation Instructions before it is used.
- Do not allow children to climb, stand or hang on the shelves in the refrigerator. They could damage the refrigerator and seriously injure themselves.
- Do not touch the cold surfaces in the freezer compartment when hands are damp or wet. Skin may stick to these extremely cold surfaces.
- Do not store or use gasoline or other flammable vapors and liquids in the vicinity of this or any other appliance. Do not store explosive substances such as aerosol cans with a flammable propellant in this appliance.
- Do not use electrical appliances inside the food storage compartments of the appliance, unless they are of the type recommended by the manufacture.
- Keep fingers out of the “pinch point” areas; clearances between the doors and between the doors and cabinet are necessarily small; be careful closing doors when children are in the area.

NOTE
We strongly recommend that any servicing be preformed by a qualified technician.

- Unplug the refrigerator before cleaning and making repairs.
- Setting temperature controls to the 0 position does not remove power to the light circuit, perimeter heaters, or evaporator fans.

SAFETY INFORMATION

GDM Installation and Maintenance Do's and Don'ts

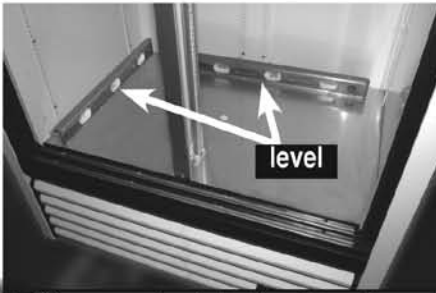

1 Once cooler is in final location, cooler should be levelled front to back and side to side.



2 Turn castors or leg levellers counter clockwise as necessary in order to properly level cooler. Add shims if castors are backed out for leveling.

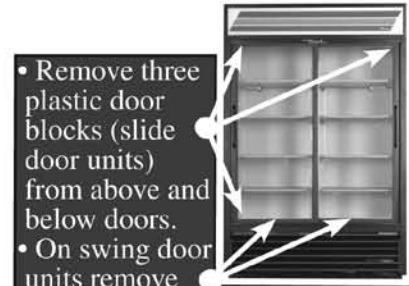

3 Remove three plastic door blocks (slide door units) from above and below doors. On swing door units remove metal door block attached to the bottom of doors. If the doors do not completely slide shut, follow steps 1 & 2 until the cooler is level.



4 Never use an extension cord! Using extension cords voids warranty!



5 Never plug in more than one unit per electrical circuit.



6 With use of a cotten swab, put a small amount of grease into bearing part of roller. Turn wheel several times to lubricate entire bearing.



7 Use only silicone spray to lubricate the door weight cord. Use a rag to clean out slide door v-tracks



8 Allow sufficient space between wall and/or another cooler for air circulation.



9 The temperature control should always be set no higher than number 5 for maximum efficiency.



10 Do not stand or place feet on the door channels.



11 When loading top shelf of cooler, do not block evaporator fan. Allow at least 4" space between the fan and product.



12 Condenser should be kept clean by vacuuming, brushing with a stiff bristle brush or using compressed air to remove dust and debris.

SAFETY INFORMATION

DANGER!
RISK OF CHILD ENTRAPMENT

PROPER DISPOSAL OF THE REFRIGERATOR

Child entrapment and suffocation are not problems of the past. Junked or abandoned refrigerators are still dangerous... even if they will sit for “just a few days.” If you are getting rid of your old refrigerator, please follow the instructions below to help prevent accidents.

Before You Throw Away Your Old Refrigerator or Freezer:

- Take off the doors.
- Leave the shelves in place so that children may not easily climb inside.

Appliance Disposal

When recycling appliance please make sure that the refrigerants are handled according to local and national codes, requirements and regulations.

Refrigerant Disposal

Your old refrigerator may have a cooling system that uses “Ozone Depleting ” chemicals. If you are throwing away your old refrigerator, make sure the refrigerant is removed for proper disposal by a qualified service technician. If you intentionally release any refrigerants you can be subject to fines and imprisonment under provisions of the environmental regulations.

USE OF EXTENSION CORDS

NEVER USE AN EXTENSION CORD! TRUE will not warranty any refrigerator that has been connected to an extension cord.

REPLACEMENT PARTS

- Component parts shall be replaced with like components.
- Servicing shall be done by authorized service personnel, to minimize the risk of possible ignition due to incorrect parts or improper service.
- Lamps must be replaced by identical lamps only.
- If the supply cord is damaged, it must be replaced by a special cord or assembly available from the manufacturer or its service agent.

SAFETY INFORMATION

WARNING!

HOW TO CONNECT ELECTRICITY

*Do not, under any circumstances, cut or remove the ground prong from the power cord.
For personal safety, this appliance must be properly grounded.*

The power cord from this appliance is equipped with a grounding plug which minimizes the possibility of electric shock hazard.

Have the wall outlet and circuit checked by a qualified electrician to make sure the outlet is properly grounded.

If the outlet is a standard 2-prong outlet, it is your personal responsibility and obligation to have it replaced with the properly grounded wall outlet.

The refrigerator should always be plugged into its own individual electrical circuit, which has a voltage rating that matches the rating plate.

This provides the best performance and also prevents overloading building wiring circuits which could cause a fire hazard from overheated wires.

Never unplug your refrigerator by pulling on the power cord. Always grip plug firmly and pull straight out from the outlet.

Repair or replace immediately all power cords that have become frayed or otherwise damaged. Do not use a cord that shows cracks or abrasion damage along its length or at either end.

When removing the refrigerator away from the wall, be careful not to roll over or damage the power cord.

If supply power cord is damaged it should be replaced with original equipment manufacture parts. To avoid hazard this should be done by a qualified service technician.

USE OF ADAPTER PLUGS

NEVER USE AN ADAPTER PLUG! Because of potential safety hazards under certain conditions, we strongly recommend against the use of an adapter plug.

The incoming power source to the cabinet including any adapters used must have the adequate power available and must be properly grounded. Only adapters listed with UL should be used.

North America Use Only!

NEMA plugs

TRUE uses these types of plugs. If you do not have the right outlet have a certified electrician install the correct power source.



115/60/1
NEMA-5-15R



115/208-230/1
NEMA-1-14-20R



115/60/1
NEMA-5-20R

INSTALLATION / OPERATION INSTRUCTIONS

INSTALLATION / OPERATION INSTRUCTIONS

OWNERSHIP

To ensure that your unit works properly from the first day, it must be installed properly. We highly recommend a trained refrigeration mechanic and electrician install your TRUE equipment. The cost of a professional installation is money well spent.

Before you start to install your TRUE unit, carefully inspect it for freight damage. If damage is discovered, immediately file a claim with the delivery freight carrier.

TRUE is not responsible for damage incurred during shipment.

REQUIRED TOOLS

- Adjustable Wrench
- Phillips Head Screwdriver
- Level

UNCRATING

The following procedure is recommended for uncrating the unit:

- Remove the outer packaging, (cardboard and bubbles or styrofoam corners and clear plastic). Inspect for concealed damage. Again, immediately file a claim with the freight carrier if there is damage.
- Move your unit as close to the final location as possible before removing the wooden skid.
- Remove door bracket on swinging glass door models (see image 1-2). Sliding glass door models contain shipping blocks (three for each door). Remove the two styrofoam blocks taped to the top of the door tracks (see image 3).

The shipping blocks are orange in color and by opening the door a little the blocks can be removed (see images 4-6). Do not throw the bracket or blocks away. For future cabinet movement the bracket and blocks will need to be installed so the glass door does not receive any damage. (See image for bracket and shipping block removal)

NOTE
Keys for coolers with door locks are located in warranty packets.

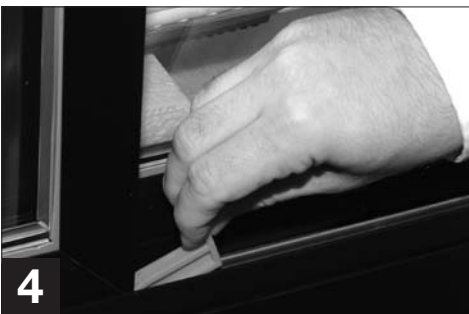

INSTALLATION / OPERATION INSTRUCTIONS

LOCATING

WARNING: Be sure there is adequate ventilation in your room. Under extreme heat conditions, (100°F+, 38°C+), you may want to install an exhaust fan.

CLEARANCES (For proper cabinet operation, clearance guidelines should be followed)

Refrigerators – 1” at the rear, 0” at the sides, and open at the top (GDM-5, -6, -7, -9 = 1” at the rear, 1” at the sides, and open at the top).

Freezers – 3” at the rear, 0” at the sides, and open at the top.

- A. Remove louver from the front of cabinet and backguard (if applicable) from rear of cabinet (see page 29).
- B. Skid bolts are located in each of 4 corners inside cabinet bottom. (See photo A).
- C. Remove skid bolts. (See photo B).
- D. Cut straps if applicable. (See photo C).
- E. Carefully lift cabinet off of skid.

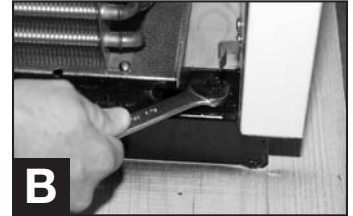
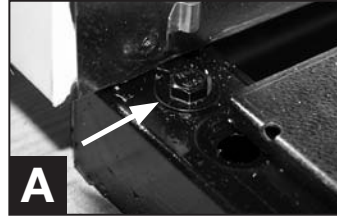

Removing skid from bottom of cabinet.

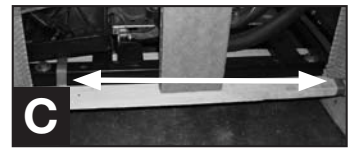

LEVELING

- A. Set unit in its final location. Be sure there is adequate ventilation in your room. Under extreme heat conditions, (100°F+, 38°C+), you may want to install an exhaust fan.

WARNING

Warranty is void if ventilation is insufficient.

- B. Proper leveling of your TRUE cooler is critical to operating success (for non-mobile models). Effective condensate removal and door operation will be effected by leveling.
- C. The cooler should be leveled front to back and side to side with a level.
- D. Ensure that the drain hose or hoses are positioned in the pan.
- E. Free plug and cord from inside the lower rear of the cooler (do not plug in).
- F. The unit should be placed close enough to the electrical supply so that extension cords are never used.

WARNING

Cabinet warranties are void if OEM power cord is tampered with. TRUE will not warranty any units that are connected to an extension cord.

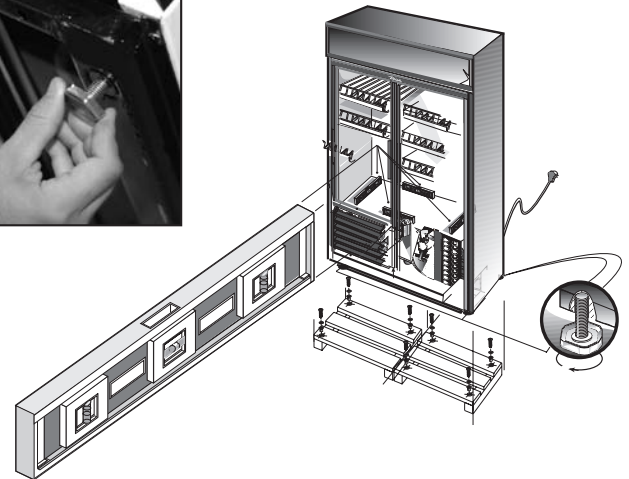

REMOTE UNITS (This section applies to remotes only!)

- Remote cabinets must be ordered as remote. We do not recommend converting from a standard self contained to remote system.
- All remote cabinets must be hard wired.
- No castors available.
- All remote cabinets come standard using 404A refrigerant.
- All remote units come standard with expansion valve, liquid line solenoid, heated condensate pan, and defrost timer when applicable.

- Contact TRUE Technical Service for BTU requirements.
- No wiring necessary between cabinet and condensing unit.
- All remote condensing units purchased from TRUE are 208/230 volts single phase.

If you have any questions regarding this section, please call TRUE at 1-(800)-325-6152.

INSTALLATION / OPERATION INSTRUCTIONS

INSTALLATION OF OPTIONAL LEGS / CASTORS

Important Safeguard for installation of leg/castor (Images 1-5 demonstrate procedure)

Securing Castors and Legs

To obtain maximum strength and stability of the unit, it is important that you make sure each castor is secure. Legs are hand-tightened securely against the lower rail assembly see image 4-5. The bearing race on the castor of the top edge of the leg must make firm contact with the rail.

Unit leveling

Four leveling shims have been provided for leveling castored units positioned on uneven floors. Shims must be positioned between rail end and bearing race.

- A. Turn the bearing race counter-clockwise until the cabinet is level. Level front to back and side to side (diagonally).
- B. Install the desired number of shims, making sure the slot of the shim is in contact with the threaded stem of the castor. (See image 2)

- C. If more than one shim is used, turn the slot at a 90° angle so they are not in line.
- D. Turn the bearing race clockwise to tighten and secure the castor by tightening the anchoring bolt with a 3/4 inch open-end wrench or the tool provided. (See image 3)

CAUTION

To avoid damage to lower rail assembly, slowly raise unit to upright position.

NOTE

Open holes located on the cross members of the frame rail should be plugged before unit is in use.



1 Thread castor into the underside of cabinet frame



2 For leveling, insert the shim between the castor and frame rail.



3 Use the tool provided to tighten the castor into place.



4 Thread leg into cabinet bottom frame rail.



5 The end of the leg is adjustable to easy leveling.

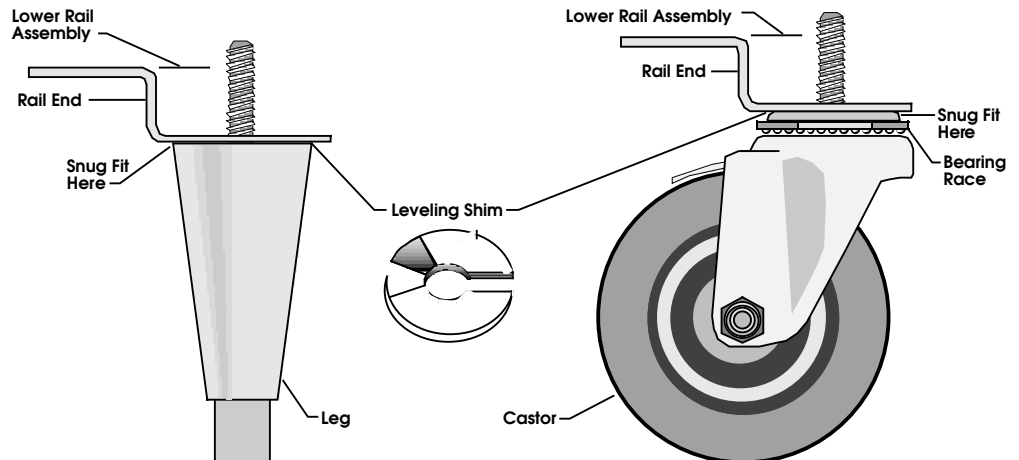

INSTALLATION / OPERATION INSTRUCTIONS

INSTALLING OPTIONAL CASTORS ON GDM-10 AND GDM-12 MODELS

Final Location

- A.** Place styrofoam corners behind cooler for cushion and carefully tilt unit on it's back.
- B.** Remove the louvered grill by removing four phillips-head screws.
- C.** Remove the four bolts from the skid with an adjustable wrench, and locate the four castors. Castors are placed inside cooler, within the bubble wrap.
- D.** Install one castor in each of the four female threaded areas as indicated.

NOTE

Two out of the four castors are designated with an "F" for front. These are provided with hand-brakes. Position these castors in FRONT of the unit.

- E.** When all castors have been threaded fully, replace grill and lift unit; positioning it into its final location.
- F.** Ensure that the two front castors are positioned FORWARD as illustrated and locked down with the hand-brakes.

WARNING

Unit may tip forward if procedure "F" is not strictly followed.

- G.** Units final location should be adequately ventilated. Conditions where heat exceeds 100°F require an exhaust fan.
- H.** Ensure that the drain hose for hoses are positioned in the pan.
- I.** Free plug and cord from inside the lower rear of the cooler (Do Not Plug In.)

WARNING

Warranty is VOID if ventilation is insufficient.

- J.** The unit should be placed close enough to the electrical supply so that extension cords are NEVER used.

WARNING

Cabinet warranties are void if OEM power cord is tampered with. TRUE will not warranty any units that are connected to an extension cord.

- K.** Proper leveling of your TRUE cooler is critical to operating success. Effective condensate removal and door operation will be effected by leveling. Adjust castors or add shims.

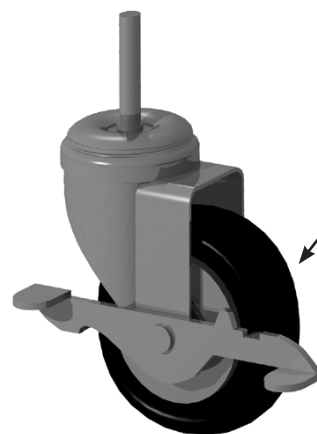

POSITIONING OF THE CASTOR IS CRITICAL. ORIENT THE CASTOR IN THE FORWARD POSITION AS SHOWN

INSTALLATION / OPERATION INSTRUCTIONS

SLIDE DOORS

STEP 1

Before removing slide door do not use the side latch. Tension on the door cord is needed to execute these operation instructions. Doors can not be removed unless placed in specific locations stated in these instructions.

STEP 2

Two Door Units: Slide the front door so it is centered on the cabinet. The door can not be removed unless it is centered. See image 1 for door channel openings and image 2 for centering door.

Three Door Units: Slide the middle door to the right side so the glass is centered with the left edge of the right side door. See image 3.



1
(Two Door Units ONLY)



2
(Two Door Units ONLY)



3
(Three Door Units ONLY)

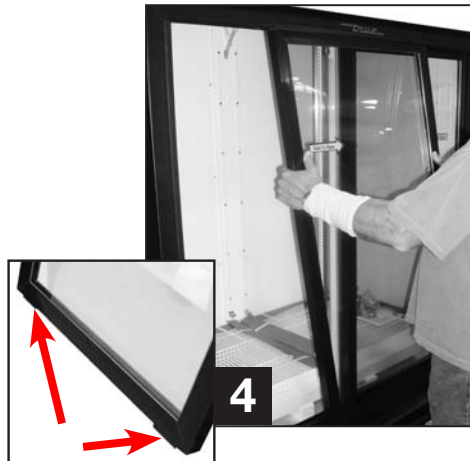

Gasket fasten to door bottom assures door will remain in track when unit is placed on uneven surface.

STEP 3

After centering the door lift it up and tilt top of door towards the back of the unit so the rollers are out of the top channel. Swing the bottom of the door out of the bottom channel. Then remove the door and set it down. See image 4.

(TWO DOOR UNITS SKIP TO STEP 6)

STEP 4

Slide right door to the left so left edge lines up with the left edge of TRUE Logo located above the door. See image 5. Then lift door out of track same way as image 4.

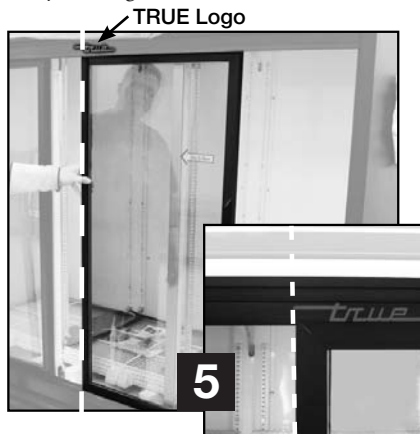

(Three Door Units ONLY)

STEP 5

Slide left door to the right so right edge lines up with the end of the TRUE Logo located at the top of the door frame. See image 6. Then lift door out of track same way as image 4.

STEP 6

Remove door cord from roller bracket. The black plastic tab holding the door cord slides the back. See images 7 & 8.

TRUE Logo



6
Image 6 (Three Door Units ONLY)



7



8

STEP 7

Let the door cord slowly retract back into the door side channel. The knot tied at the end of the door cord will keep the cord from retracting all the way back into the door channel. See image 9.

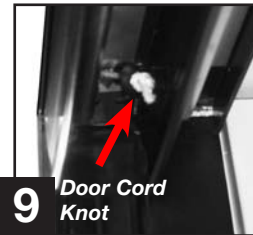

9 Door Cord Knot



P-Clip keeps cord in-place (prevents cord damage).

TO ADJUST SLIDE DOOR

STEP 1

After cabinet is installed in a final location and correctly leveled check for any openings when the slide doors are completely closed. If there are any gaps/openings between the closed doors and cabinet, the doors will need to be adjusted.

STEP 2

Using a 7/16" wrench or adjustable wrench and 1/8" allen wrench loosen roller and move along slotted hole. After adjustment has been made tighten the roller into place. See image 10.



10

INSTALLATION / OPERATION INSTRUCTIONS

CONDUCTORS AND CIRCUITS

Wire Gauge for 2% Voltage Drop in Supply Circuits.

115 Volt Amps	Distance In Feet To Center of Load											
	20	30	40	50	60	70	80	90	100	120	140	160
2	14	14	14	14	14	14	14	14	14	14	14	14
3	14	14	14	14	14	14	14	14	14	14	14	14
4	14	14	14	14	14	14	14	14	14	12	12	12
5	14	14	14	14	14	14	14	12	12	12	10	10
6	14	14	14	14	14	14	12	12	12	10	10	10
7	14	14	14	14	14	12	12	12	10	10	10	8
8	14	14	14	14	12	12	12	10	10	10	8	8
9	14	14	14	12	12	12	10	10	10	8	8	8
10	14	14	14	12	12	10	10	10	10	8	8	8
12	14	14	12	12	10	10	10	8	8	8	8	6
14	14	14	12	10	10	10	8	8	8	6	6	6
16	14	12	12	10	10	8	8	8	8	6	6	6
18	14	12	10	10	8	8	8	8	8	8	8	5
20	14	12	10	10	8	8	8	6	6	6	5	5
25	12	10	10	8	8	6	6	6	6	5	4	4
30	12	10	8	8	6	6	6	6	5	4	4	3
35	10	10	8	6	6	6	5	5	4	4	3	2
40	10	8	8	6	6	5	5	4	4	3	2	2
45	10	8	6	6	6	5	4	4	3	3	2	1
50	10	8	6	6	5	4	4	3	3	2	1	1

Wire Gauge for 2% Voltage Drop in Supply Circuits.

230 Volt Amps	Distance In Feet To Center of Load											
	20	30	40	50	60	70	80	90	100	120	140	160
5	14	14	14	14	14	14	14	14	14	14	14	14
6	14	14	14	14	14	14	14	14	14	14	14	12
7	14	14	14	14	14	14	14	14	14	14	12	12
8	14	14	14	14	14	14	14	14	14	12	12	12
9	14	14	14	14	14	14	14	14	12	12	12	10
10	14	14	14	14	14	14	14	12	12	12	10	10
12	14	14	14	14	14	14	12	12	12	10	10	10
14	14	14	14	14	14	12	12	12	10	10	10	8
16	14	14	14	14	12	12	12	10	10	10	8	8
18	14	14	14	12	12	12	10	10	10	8	8	8
20	14	14	14	12	10	10	10	10	10	8	8	8
25	14	14	12	12	10	10	10	10	8	8	6	6
30	14	12	12	10	10	10	8	8	8	6	6	6
35	14	12	10	10	10	8	8	8	8	6	6	5
40	14	12	10	10	8	8	8	6	6	6	5	5
50	12	10	10	8	6	6	6	6	6	5	4	4
60	12	10	8	6	6	6	6	6	5	4	4	3
70	10	10	8	6	6	6	5	5	4	4	2	2
80	10	8	8	6	6	5	5	4	4	3	2	2
90	10	8	6	6	5	5	4	4	3	3	1	1
100	10	8	6	6	5	4	4	3	3	2	1	1

INSTALLATION / OPERATION INSTRUCTIONS

ELECTRICAL INSTRUCTIONS

- A. Before your new unit is connected to a power supply, check the incoming voltage with a voltmeter. If anything less than 100% of the rated voltage for operation is noted, correct immediately.
- B. All units are equipped with a service cord, and must be powered at proper operating voltage at all times. Refer to cabinet data plate for this voltage.

TRUE requires that a sole use circuit be dedicated for the unit. Failure to do so voids warranty.

WARNING
Compressor warranties are void if compressor burns out due to low voltage.

WARNING
Power supply cord ground should not be removed!

WARNING
Do not use electrical appliances inside the food storage compartments of the appliances unless they are of the type recommended by the manufacturer.

NOTE
To reference wiring diagram - Remove front louvered grill, wiring diagram is positioned on the inside cabinet wall.

SEALING CABINET TO FLOOR

Step 1 - Position Cabinet

Allow one inch between the wall and rear of the GDM refrigerator to assure proper ventilation. For GDM freezers 3 inches between the wall and rear of the cabinet will assure proper ventilation.

Step 2 - Level Cabinet

Cabinet should be level, side to side and front to back. Place a carpenter's level in the interior floor in four places:

- A. Position level in the inside floor of the unit near the doors. (Level should be parallel to cabinet front). Level cabinet.
- B. Position level at the inside rear of cabinet. (Again level should be placed parallel to cabinet back).
- C. Perform similar procedures to steps a & b by placing the level on inside floor (left and right sides - parallel to the depth of the cooler). Level cabinet.

Step 3

Draw an outline on the base on the floor.

Step 4

Raise and block the front side of the cabinet.

Step 5

Apply a bead of "NSF Approved Sealant", (see list below), To floor on half inch inside the outline drawn. The bead must be heavy enough to seal the entire cabinet surface when it is down on the sealant.

Step 6

Raise and block the rear of the cabinet.

Step 7

Apply sealant on floor as outline in Step 5. on other three sides.

Step 8

Examine to see that cabinet is sealed to floor around entire perimeter.

Note
Asphalt floors are very susceptible to chemical attack. A layer of tape on the floor prior to applying the sealant will protect the floor.

NSF Approved Sealants:

1. Minnesota Mining #ECU800 Caulk
2. Minnesota Mining #ECU2185 Caulk
3. Minnesota Mining #ECU1055 Bead
4. Minnesota Mining #ECU1202 Bead
5. Armstrong Cork - Rubber Caulk
6. Products Research Co. #5000 Rubber Caulk
7. G.E. Silicone Sealer
8. Dow Corning Silicone Sealer

INSTALLATION / OPERATION INSTRUCTIONS

STARTUP

- A.** The compressor is ready to operate. Plug in the cooler.
- B.** Temperature control set at No. 4 position gives refrigerators an approximate temperature of 35°F. Allow unit to function several hours, completely cooling cabinet before changing the control setting.
- C.** Excessive tampering with the control could lead to service difficulties. Should it ever become necessary to replace temperature control, be sure it is ordered from your TRUE dealer or recommended service agent.
- D.** Good air flow in your TRUE unit is critical. Be careful to load product so that it neither presses against the back wall, nor comes within four inches of the evaporator housing. Refrigerated air off the coil must circulate down the back wall.

NOTE

If the cooler is disconnected or shut off, wait five minutes before starting again.

RECOMMENDATION

Before loading product we recommend you run your TRUE unit empty for two to three days. This allows you to be sure electrical wiring and installation are correct and no shipping damage has occurred. Remember, our factory warranty does not cover product loss!

REPLACEMENT PARTS

TRUE maintains a record of the cabinet serial number for your cooler. If at any time during the life of your cooler, a part is needed, you may obtain this part by furnishing the model number and serial number to the company from whom you purchased the cooler. Call Toll-Free: (800)-424-TRUE (Direct to Parts Department). (800)-325-6152 (U.S.A. & Canada only) or call: (636)-240-2400.

SLIDE DOOR OPERATION

When installing unit, loading product or rearranging shelving, the slide doors must be propped open with the door latch. The door latch is located on the inside wall of the unit. (See image 1).

If the door must be removed open it to full extension and then lift the door latch. Then lift the door up and out of the bottom track and then out of the top door frame. (See image 2). Unhook the door cord from the top of the door. (See image 3). Set the door to the side with the bottom rollers facing up. Never set the slide door on it's rollers. Resting door on rollers can cause damage and the door will not operate correctly when opening and closing. To reinstall door do the steps in reverse order.

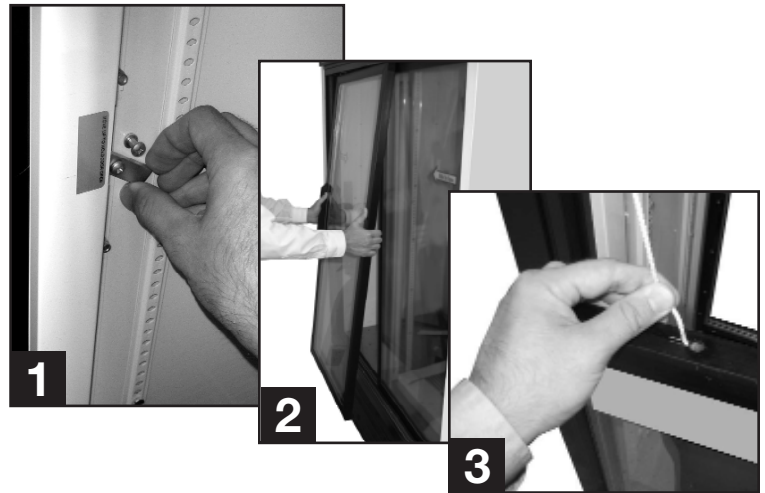

INSTALLATION / OPERATION INSTRUCTIONS



(On GDM Freezers, the LAE Electronic Control is located on inside of cooler's grill.)



IF YOUR CABINET IS BUILT WITH THIS TEMPERATURE CONTROL, PLEASE SEE THE FOLLOWING INSTRUCTIONS.

LAE CONTROL SAFETY INFORMATION

SEQUENCE OF OPERATION

1. Cabinet is plugged in.
 - a. Display will illuminate.
 - b. Interior light will illuminate on glass door models only. (If lights do not come on please see instructions on following page(s).) Solid door cabinet lights are controlled by door switch.
2. After the LAE control preprogrammed time delay of 3 minutes, the compressor and evaporator fan(s) will start if the control is calling for cooling.
 - a. Control may be already pre-programmed from the factory so at the start of every compressor cycle or during a defrost cycle, the condenser fan(s) will reverse for 30 seconds to blow dirt off the condensing coil.
3. The LAE control will cycle the compressor but may also cycle evaporator fan(s) on and off determined by the Set-Point and Differential temperatures. (If the Set-Point needs to be changed due to conditions please see instructions on the following page(s).)
 - a. The **Set-Point** is the preprogrammed temperature which shuts off the compressor.
 - b. The **Differential** is the preprogrammed temperature that is added to the Set-Point temperature that will start the compressor.

Example: If the Set-Point is -9°F/-23°C and the Differential is 10°F/5°C

(Set-Point) -9°F + 10 (Differential) = 1°F

Or

(Set-Point) -23°C + 5 (Differential) = -18°C

The compressor and evaporator fan(s) will cycle off -9°F/-23°C
and back on at 1°F/-18°C

4. The LAE control may be preprogrammed to initiate defrost by interval or at specific times of day. (If additional Defrost Intervals or Cycles are needed or a Manual Defrost is required due to conditions please see instructions on the following page(s).)
 - a. At this time the “dEF” will appear on the display and compressor will turn off until a preprogrammed temperature or duration is reached. During this time for freezers only, evaporator fan(s) will also turn off and the coil heater and drain tube heaters will also be energized.
 - b. After the preprogrammed temperature or duration for defrost has been reached there may be a short delay for both the compressor and evaporator fans to restart. At this time “dEF” may still appear on the display for a short time.

True Manufacturing recommends that ONLY the Set-Point and/or Defrost Interval may be adjusted due to certain conditions.

This sequence is NOT model specific.

If you have any questions, please contact the Technical Service Department.

Phone: 800-325-6152 • Email: service@truemfg.com

..... www.truemfg.com

SAFETY INFORMATION LAE Electronic Control



LAE Control Icons	
	Compressor Running
	Evaporator Fan Running
	Cabinet in Defrost
	Activation of 2nd Parameter Set - NA
	Alarm - NA



Info/Set Point Button



Manual Defrost/Down Button



Manual Activation/Up Button

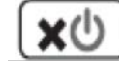

Stand-By Button

LOCKING & UNLOCKING LAE CONTROLLER

WHY:

LOCKING OF CONTROL IS NECESSARY TO PREVENT CHANGES TO PROGRAM THAT MAY AFFECT CABINET OPERATION

HOW:

- A.** To change lock setting press and release the info button . "t1" will appear. See image 1.
Press the up button until "Loc" appears. See image 2.
- B.** While pressing and holding the info button press the up or down button to change the lock settings. If "no" appears, the controller is unlocked. If "yes" appears, the controller is locked. See images 3 and 4.
- C.** Once the lock setting has been set correctly release the info button .
Wait 5 seconds for the display to show temperature. See image 5.



Image 3:
If "no" appears on screen, the controller is unlocked.



Image 4:
If "yes" appears on screen, the controller is locked.



SAFETY INFORMATION
LAE Electronic Control



LAE Control Icons	
	Compressor Running
	Evaporator Fan Running
	Cabinet in Defrost
	Activation of 2nd Parameter Set - NA
	Alarm - NA



Info/Set Point Button



Manual Defrost/Down Button



Manual Activation/Up Button



Stand-By Button

HOW TO TURN GLASS DOOR MODEL LIGHTS ON/OFF

May need to unlock control.

WHY:

LIGHT MAY BE CONTROLLED BY LAE CONTROLLER OR INTERIOR LIGHT SWITCH.

HOW:

- A.** To control interior/sign lights by the LAE Controller, press and release the “Manual Activation” button.
- B.** To control interior/sign lights by the interior door switch, depress the rocker switch to the “ON” position. Light Switch is located on inside top right of the ceiling.

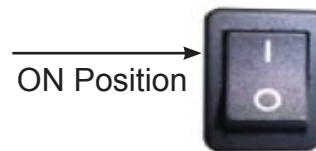

SAFETY INFORMATION LAE Electronic Control



LAE Control Icons	
	Compressor Running
	Evaporator Fan Running
	Cabinet in Defrost
	Activation of 2nd Parameter Set - NA
	Alarm - NA



Info/Set Point Button



Manual Defrost/Down Button



Manual Activation/Up Button



Stand-By Button

HOW TO CHANGE THE "SET POINT"





May need to unlock control.

WHY:

THE SET POINT IS THE TEMPERATURE AT WHICH THE COMPRESSOR WILL SHUT OFF.

Please note that the "set point" IS NOT the cabinet holding temperature.

HOW:

- A.** To see the set point, press and hold the info button. See image 1.
- B.** While still holding the info button , press the up  or down  button to change the "set point".
- C.** Once the "set point" has been set correctly release the info button . The display will show temperature. See image 2.



LAE Electronic Control



LAE Control Icons	
	Compressor Running
	Evaporator Fan Running
	Cabinet in Defrost
	Activation of 2nd Parameter Set - NA
	Alarm - NA



Info/Set Point Button



Manual Defrost/Down Button



Manual Activation/Up Button



Stand-By Button

HOW TO INITIATE A MANUAL DEFROST

May need to unlock control.

WHY:

A ONE TIME ADDITIONAL DEFROST MAY BE NECESSARY TO CLEAR ACCUMULATED FROST/ICE FROM EVAPORATOR COIL.

HOW:

The method to initiate a manual defrost is determined by the Defrost Mode Parameter "DTM" preprogrammed in the controller.

A. REGULAR TIME DEFROST (TIM)

If controller is preprogrammed for "TIM", press and release the Manual Defrost button until "dEF" appears.

B. REAL TIME CLOCK (RTC)

If controller is preprogrammed for "RTC" press the and hold the Manual Defrost button for 5 seconds until "dh1" appears. Release the Manual Defrost button and then press and hold for an additional 5 seconds until "dEF" appears.

DEFROST WILL ONLY TERMINATE ONCE A SPECIFIC PRESET TEMPERATURE OR A PRESET TIME DURATION IS REACHED.

LAE Electronic Control SAFETY INFORMATION



LAE Control Icons	
	Compressor Running
	Evaporator Fan Running
	Cabinet in Defrost
	Activation of 2nd Parameter Set - NA
	Alarm - NA



Info/Set Point Button



Manual Defrost/Down Button



Manual Activation/Up Button

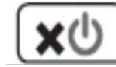

Stand-By Button

HOW TO CHANGE “DEFROST INTERVALS”

May need to unlock control.

This can only be changed if defrost mode parameter “DFM” is set for “TIM”.

WHY:

THE DEFROST INTERVAL IS THE TIME DURATION BETWEEN DEFROST CYCLES.

The Defrost Interval time starts when the cabinet is supplied power or after a manual defrost.

HOW:

- A.** To see the set point, press and hold the info button and the stand-by button at the same time. “ScL” will appear. See image 1.
- B.** Push the up button until “dFt” appears. See image 2.
- C.** Press and hold the info button to see the “defrost interval time”. See image 3.
- D.** While pressing and holding the info button , press the up or down button to change the “defrost interval times” (higher the number the less frequent the cabinet will defrost).
- E.** Once the “defrost interval time” has been changed, release the info button .
Wait 30 seconds for the display to show temperature. See image 4.



SAFETY INFORMATION

DISPLAY

DISPLAY	
dEF Defrost in progress	h _i Room high temperature alarm
oFF Controller in stand-by	L _o Room low temperature alarm
d _o Door open alarm	E ₁ Probe T1 failure
t ₁ Instant probe 1 temperature	E ₂ Probe T2 failure
t ₂ Instant probe 2 temperature	E ₃ Probe T3 failure
t ₃ Instant probe 3 temperature	t _h Maximum probe 1 temperature recorded
n _m Minutes of the Real Time Clock	t _{L_o} Minimum probe 1 temperature recorded
hr ₅ Hours of the Real Time Clock	L _o c Keypad state lock

Resistance Readings for LAE Probes			SAFETY INFORMATION				LAE Controller Parameter Settings for Celsius		
Temperaure		K-ohm	SCL	1C	ADO				
C	F		SPL	(X-32) / 1.8	AHM				
-40	-40	195.652	SPH	(X-32) / 1.8	AHT	(X-32) / 1.8			
-35	-31	148.171	SP	(X-32) / 1.8	ACC				
-30	-22	113.347	C-H		IISM				
-25	-13	87.559	HYS	(X) / 1.8	IISL	(X-32) / 1.8			
-20	-4	68.237	CRT		IISH	(X-32) / 1.8			
-15	5	53.650	CT1		IISP	(X-32) / 1.8			
-10	14	42.506	CT2		IIHY	(X) / 1.8			
-5	23	33.892	CSD		IIFC				
0	32	27.219	DFM		HDS				
5	41	22.021	DFT		IIDF				
10	50	17.926	DH1		SB				
15	59	14.674	DH2		DS				
20	68	12.081	DH3		DI2				
25	77	10.000	DH4		STT				
30	86	8.315	DH5		EDT				
35	95	6.948	DH6		LSM				
40	104	5.834	DLI	(X-32) / 1.8	OA1				
45	113	4.917	DTO		OA2				
50	122	4.161	DTY		2CD				
55	131	3.535	DPD		INP				
60	140	3.014	DRN		OS1	(X) / 1.8			
65	149	2.586	DDM		T2				
70	158	2.228	DDY		OS2	(X) / 1.8			
75	167	1.925	FID		T3				
80	176	1.669	FDD	(X-32) / 1.8	OS3	(X) / 1.8			
85	185	1.452	FTO		TLD				
90	194	1.268	FCM		SIM				
95	203	1.145	FDT	(X) / 1.8	ADR				
100	212	0.974	FDH	(X) / 1.8					
105	221	0.858	FT1						
110	230	0.758	FT2						
115	239	0.671	FT3						
120	248	0.596	ATM						
125	257	0.531	ALA	(X-32) / 1.8					
			AHA	(X-32) / 1.8					
			ALR	(X) / 1.8					
			AHR	(X) / 1.8					
			ATI						
			ATD						

All Parameters with formula above need to be converted for Celsius applications.

Example:
 If current SPL is set for 20 degrees F the formula is (X-32) / 1.8
 (20-32) / 1.8 = -6.7 Celsius

We want to make it very clear that all parameter set points on the LAE controller have been set at the factory to optimize performance and adjusting any of these parameters in the field will affect the cabinet's performance and could void the Warranty.

INSTALLATION / OPERATION INSTRUCTIONS

TEMPERATURE CONTROL ADJUSTMENT FOR HIGH ALTITUDE ONLY!

TERMS:

Cut-out - Temperature sensed by the controller that shuts the compressor off.

Cut-in - Temperature sensed by the controller that turns the compressor on.

REQUIRED TOOLS

- Phillips Head Screwdriver
- 5/64" or 2 mm Allen Wrench
- T-7 Torx Wrench

STEP 1

Unplug the cooler.

STEP 2

Remove the screws that secure the temperature control to the evaporator fan housing in the ceiling of the cabinet. See image to the right for temperature control location.

STEP 3

Pull out gently from cabinet.

NOTE:

Mechanical temperature controllers are affected when functioning at high altitude. The cut-in and cut-out temperatures will be colder than when the controller functions closer to sea level

STEP 4

For high elevation installations, it may be necessary to "warm-up" the set points. To make the adjustment, insert the appropriate tool in each adjustment screw and turn 1/4 of a revolution clockwise (to the right). This procedure will adjust both the cut-in and cut-out about 2°F warmer.

STEP 5

Make sure to reconnect the pink wire to the proper spade terminal when reinstalling.

Danfoss Temperature Control (High Altitude Adjustment Only!)

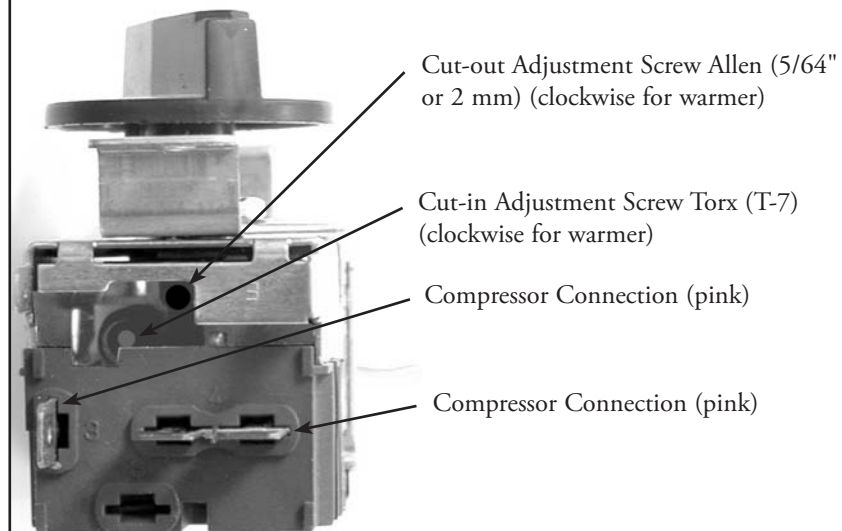

INSTALLATION / OPERATION INSTRUCTIONS

SHELVING INSTALLATION / OPERATION & LIGHT SWITCH LOCATION

SHELF & ORGANIZER INSTALLATION:

Step 1

- A.** Hook shelf clips onto shelf standards. (see illustration).
- B.** Position all four shelf clips equal in distance from the floor for flat shelves.
- C.** Lower front of gravity feed TrueTrac organizers to enable proper feed.

WIRE SHELVES:

Wire shelves are oriented so that cross support bars are facing down.

NOTE

GDM-5 models include an airflow guard on the rear of shelves to maintain an air space at the rear of the cabinet. (see illustration).

TrueTrac ORGANIZERS:

TrueTrac organizers for Glass Door Merchandisers come with a package of shelf retainer clips. Install clip on the side to the rear of organizer (see illustration) to end of organizer that rests against left or right outside wall.

With correct installation, the retainer clip should separate the rear of the organizer from the rear interior wall of the cabinet.

NOTE

No retainer clips needed on center organizers of a GDM-69.

Step 2

Place shelves or organizers on shelf clips making sure all corners are seated properly.

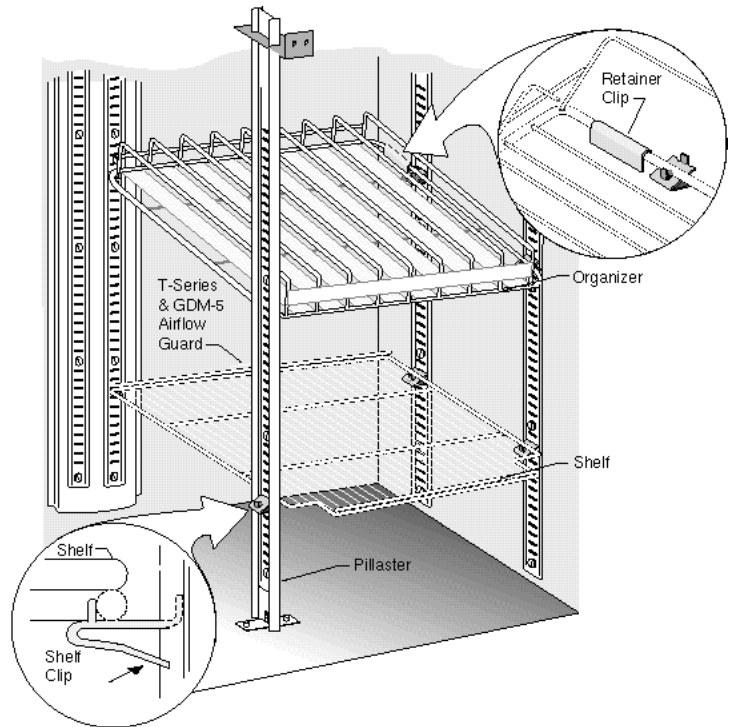

Shelf Installation Tips

- 1.** Install all the shelf clips before installing the shelves.
- 2.** Start at the bottom in terms of shelf installation and work your way up.
- 3.** Always lay the back of each shelf down on the rear clips before the front.

LIGHT SWITCH LOCATION:

Light switch location depends upon the GDM model. Most GDM models will have the light switch located on the right side of the ceiling inside the unit. Most instances the switch is located next to the temperature control. GDM-49's and 72's have the switch located on the right side of the evaporator housing along the interior ceiling. GDM-9's, 5's, and GDM-5PT's have the switch located on the left side of the ceiling. Some convenience store GDM's have the switch located behind the sliding doors above the light bulb for example the GDM-33SSL-54 and the GDM-33CPT-54. G4SM-23 models have an additional switch for the rotating display shelves. The switch for the rotating shelves in the G4SM-23 models is located under the sign frame.

WARNING

Do not use pliers or any crimping tools when installing shelf clips. Altering shelf clips in any way can lead to shelving instability.

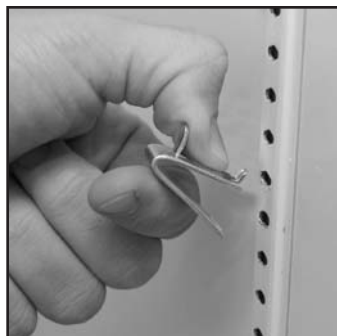
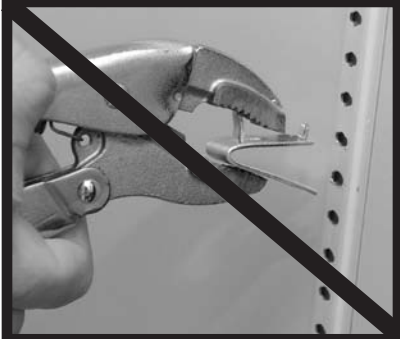

Install the top tab of the shelf clip into the proper hole. Push up on the bottom of the clip. Bottom tab of the shelf clip will fit tightly. You may need to squeeze or twist the bottom of the shelf clip to install.

INSTALLATION / OPERATION INSTRUCTIONS

INSTALLING *TrueFlex* BOTTLE ORGANIZERS (20 OZ.)

NOTE

When installing shelves, be sure to plan adequate space between shelves for product to be stocked and removed.

Step 1

Install wire shelves so rear shelf clips are four slots higher than front shelf clips (for gravity feed). To prevent shelves from sliding forward be sure to install shelf retainer clips (image 1).

Shelf retainer clip installation, both sides. (retainer clip position varies depending on model, GDM-12 shown)

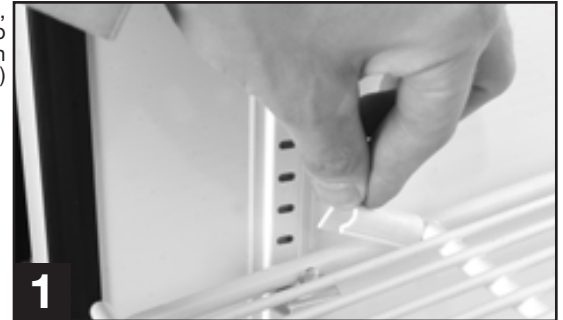

Step 2

Place TrueFlex organizer along tank side. Guide bottom tabs between the first and third wire supports as shown (image 2).

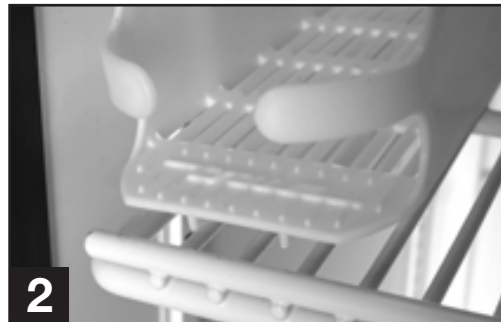

Guide bottom tabs between first and third wire supports.

Step 3

Firmly press and slide hand along inside of TrueFlex organizer until it snaps in place on top of shelf (image 3). Tabs grip between shelf wire supports (image 3a).



Press organizer down until bottom tabs snap into place between shelf wire supports.

Step 4

Line up second TrueFlex organizer against the side of the first one and press into place as before. Continue the process until shelf is filled out (image 4).



Tabs snap in place under wire shelf supports.

NOTE

Organizers may not fill entire width of shelf.



Organizers in place.



Organizers merchandised with 20 oz. bottles.

INSTALLATION / OPERATION INSTRUCTIONS

**FREEZER DEFROST TIME CLOCK
OPERATION (Grasslin Timer)**

RECOMMENDED DEFROST SETTINGS:

TRUE Manufacturing has factory set your defrost time clock to a recommended time and duration defrost scenario. All refrigeration equipment operating below 30°F will accumulate frost on the evaporator coil and will require routine defrost. Your TRUE equipment has been designed for three defrost periods (6:00 a.m., 2:00 p.m. and 10:00 p.m.). If you decide to deviate from these defrost time settings please follow the procedures for adjustment below.

REQUIRED TOOLS

- Phillips Head Screwdriver
- 1/4" Nut Driver or Socket

Locating The Defrost Timer:

Take off louvered grill assembly by removing four (4) corner screws.

Defrost timer is located in the lower right corner behind the louvered grill (inside galvanized electrical box).

Two Door Models:

Defrost timer is located in the middle of the cabinet, behind the louvered grill. Timer is mounted to the left of the centered ballast box (Inside of gray timer box).

Three Door Models:

Defrost timer is located on the left upright post behind the louvered grill (Inside of gray timer box).

**Setting the timer:
(UNPLUG UNIT FROM
POWER SUPPLY!)**

**DO NOT SET THE TIME BY
ROTATING THE "OUTER" DIAL.**

Turn the minute hand clockwise until the time of day on the outer dial is aligned with the triangle marker on the inner dial (two o'clock position).

Adjusting The Defrost Timer:
(time initiated, time or temperature terminated)

Your TRUE freezer contains a defrost system that is temperature terminated, however the time clock has been designed with a time termination back-up so that the defrost period will not exceed thirty minutes. While TRUE requires a minimum 3 defrost periods not to exceed 30 minutes the procedure on this page should be followed to customize your specific needs.

NOTICE

If timer is not set for a minimum of 3 defrost per day for 30 minutes each, the coil may develop excessive frost. This may lead to system failure and product loss, which is not covered under warranty.

The following procedure may be followed to customize your needs.

High usage, high temperature, and high humidity may require 4 defrost settings per day.

WARNING

Always follow the manufacturer's recommended settings when programming the amount and duration of the defrost cycles.

STEP 1

The white tabs located on the outmost area of the time clock have been factory set for (6:00 a.m., 2:00 p.m., and 10:00 p.m.). Each tab represents 15 minutes of defrost time. Notice that at each defrost time two white tabs are set for 15 minutes each for a total of 30 minutes of defrost.

STEP 2

In order to program the time to begin the defrost cycle, flip the white tabs out to set the defrost time. To eliminate a defrost time flip the white tabs back toward the center of the Defrost Timer.

STEP 3

TRUE recommends a 30 minute defrost cycle three times per day.



Defrost Timer Image 1

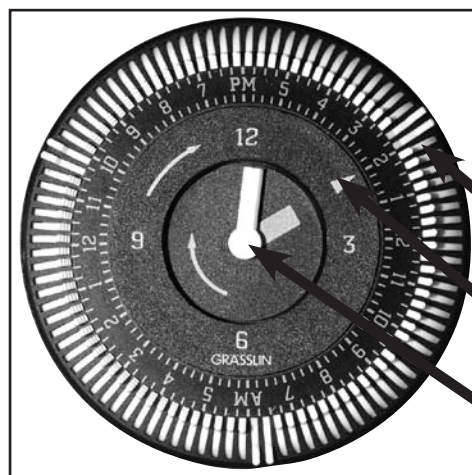

Defrost Timer Image 2

Outer most dial. White tabs represent 15 minutes of defrost time.

Time of day.

Inner most dial.

INSTALLATION / OPERATION INSTRUCTIONS

IF THE COMPRESSOR WILL NOT RUN

1. If there is no voltage at the compressor terminals, follow the wiring diagram and check back from compressor to the power supply to find where the circuit is interrupted.

2. If power is available at the compressor terminals, and the compressor does not run, check the voltage at the compressor terminals while attempting to start the compressor.

If voltage at the compressor terminals is below 90% of the nameplate voltage, it is possible the motor may not develop sufficient torque to start. Check to determine if wire sizes are adequate, electrical connections are loose, the circuit is overloaded, or if the power supply is inadequate.

3. On single phase compressors, a defective capacitor or relay may prevent the compressor starting. If the compressor attempts to start but is unable to do so, or if there is a humming sound, check the relay to see if the relay contacts are damaged or fused. The relay points should be closed during the initial starting cycle, but should open as the compressor comes up to speed.

Remove the wires from the starting relay and capacitors. Use a high voltage ohmmeter to check for continuity throughout the relay coil. Replace the relay if there is not continuity. Use an ohmmeter to check across the relay contacts. Potential relay contacts are normally closed when the relay is not energized, current relay contacts are normally open. If either gives an incorrect reading, replace the relay. Any capacitor found to be bulging, leaking, or damaged should be replaced.

Make sure capacitors are discharged before checking. Check for continuity between each capacitor terminal and the case. Continuity indicates a short, and the capacitor should be replaced.

Substitute a "known to be good" start capacitor if available. If compressor then starts and runs properly, replace the original start capacitor.

If a capacitor tester is not available, an ohmmeter may be used to check run and start capacitors for shorts or open circuits. Use an ohmmeter set to its highest resistance scale, and connect prods to capacitor terminals.

a) With a good capacitor, the indicator should first move zero, and then gradually increase to infinity.

b) If there is no movement of the ohmmeter indicator, an open circuit is indicated.

c) If the ohmmeter indicator moves to zero, and remains there or on a low resistance reading, a short circuit is indicated. Defective capacitors should be replaced.

4. If the correct voltage is available at the compressor terminals, and no current is drawn, remove all wires from the terminals and check for continuity through the motor windings. On single phase motor compressors, check for continuity from terminals C to R, and C to S. On compressors with line break inherent protectors, an open overload protector can cause a lack of continuity. If the compressor is warm, wait one hour for the compressor to cool and recheck. If continuity cannot be established through all motor windings, the compressor should be replaced.

Check the motor for ground by means of a continuity check between the common terminal and the compressor shell. If there is a ground, replace the compressor.

5. If the compressor has an external protector, check for continuity through the protector or protectors. All external inherent protectors on compressors can be replaced in the field.

IF THE MOTOR COMPRESSOR STARTS BUT TRIPS REPEATEDLY ON THE OVERLOAD PROTECTOR

1. Check the compressor suction and discharge pressures while the compressor is operating. Be sure the pressures are within the limitations of the compressor. If pressures are excessive it may be necessary to clean the condenser, purge air from the system, replace crankcase pressure regulating valve.

An excessively low suction pressure may indicate a loss of charge.

On units with no service gauge parts where pressures can be checked, check condenser to be sure it is clean and fan is running. Excessive temperatures on suction and discharge line may also indicate abnormal operating conditions.

2. Check the line voltage at the motor terminals while the compressor is operating. The voltage should be within 10% of the nameplate voltage rating. If outside those limits, the voltage supply must be brought within the proper range, or a motor compressor with different electrical characteristics must be used.

3. Check the amperage drawn while the compressor is operating. Under normal operating conditions, the amperage drawn will seldom exceed 110% of the nameplate amperage. High amperage can be caused by low damage, defective running capacitors, or a defective starting relay.

INSTALLATION / OPERATION INSTRUCTIONS

4. If all operating conditions are normal, the voltage supply at the compressor terminals balanced and within limits, the compressor crankcase temperature within normal limits, and the amperage drawn within the specified range, the motor protector may be defective, and should be replaced.

If the operating conditions are normal and the compressor is running excessively hot for no observable reason, or if the amperage drawn is above the normal range and sufficient to repeatedly trip the protector, the compressor has internal damage and should be replaced.

IF THE COMPRESSOR RUNS BUT WILL NOT REFRIGERATE

1. Check the refrigerant charge. Check the evaporator surface to determine if it is evenly cold throughout, or if partially starved. A lack of charge may be indicated by light, fluffy frost at the evaporator inlet. Add refrigerant if necessary.

2. Check the compressor suction pressure. An abnormally low pressure may indicate a loss of refrigerant charge, a malfunctioning capillary tube, a lack of evaporator capacity possibly due to icing or low air flow, or a restriction in the system.

Often a restriction in a drier or strainer can be identified by frost or a decrease in temperature across the restriction due to the pressure drop in the line. This will be true only if liquid refrigerant is in the line at the restricted point, since any temperature change due to restriction would be caused by the flashing of liquid into vapor as the pressure changes.

Any abnormal restriction in the system must be corrected.

3. Check the compressor discharge pressure. An abnormally high discharge pressure can cause a loss of capacity, and can be caused by a dirty condenser, a malfunctioning condenser fan, or air in the system.

4. If the suction pressure is high, and the evaporator and condenser are functioning normally, check the compressor amperage draw. An amperage draw near or above the nameplate rating indicates normal compressor or unit may have damaged valves.

An amperage draw considerably below the nameplate rating may indicate a broken suction reed or broken connecting rod in the compressor.

IF THE MOTOR COMPRESSOR STARTS BUT TRIPS REPEATEDLY ON THE OVERLOAD PROTECTOR

1. Defrost Time Clock

- A. Check timer motor to be sure it runs.
- B. Check contacts on the defrost timer.
- C. Check solenoid windings for continuity to ensure contact switching.
- D. Check to be sure defrost actuator pins are in proper position.
- E. Check all wires in the timer for tightness to terminals and broken wires.

2. Defrost Control On The Evaporator Drain Pan

A. If the defrost time is always 35 minutes (or whatever duration the elapsed time adjustment is set at) and the fan motors do not delay after a defrost cycle and it has been determined that the solenoid in the defrost clock is functioning, change the defrost control in the evaporator compartment in the top of the freezer. This control is attached to the evaporator drain pan.

3. Coil Defrost Heater

A. Lower the evaporator cover. Disconnect the coil heater by removing the wire nuts at the point where the heater joins the electrical circuit of the freezer in the evaporator compartment. Check heater for continuity with an ohmmeter. If the heater is defective, cut the bale wires holding the heater to the coil and remove the heater. Replace with a new heater using bale wires provided.

4. Drain Tube Heater

A. Lower the evaporator cover. Disconnect the drain tube heater by removing the wire nuts at the point where the heater joins the electrical circuit of the freezer in the evaporator compartment. Check the drain tube heater with an ohmmeter.

B. If the drain tube heater is defective, disconnect the drain tube from the rigid plastic drain, bend the tabs that hold the evaporator drain pan to the evaporator cover and raise the drain pan so that the flexible heater is visible, pull heater out of the plastic drain tube and replace. Connect heater to the electrical circuit in the evaporator compartment.

5. Cabinet Temperature Control

A. Remove the two screws on the right side of the evaporator housing that holds the control mounting plate. Reach behind the evaporator housing on the control side of the cabinet and pull the control bulb out of the receptacle in the roof of the cabinet. Disconnect the wires from the control. Check control for continuity, replace if defective.

INSTALLATION / OPERATION INSTRUCTIONS

Light Cover Installation for GDM-10F & GDM-12F

IMPORTANT

Before installing lamp cover turn cabinet on and allow it to reach temperature.

STEP 1

Locate rubber gasket behind lamp holder mounted to evaporator housing. (See Image 1).

STEP 2

Fit the bottom edge of the lamp cover into the bottom groove of the rubber gasket and rotate upwards while working the edges into the rest of the rectangular groove. (See Images 2-3). (slide fingers underneath top edges of rubber gasket and push rubber over the top lip of the lamp shield).

STEP 3

Be sure lamp cover is seated properly in rubber gasket.

NOTE

If cabinet is turned off and interior allowed to warm up lamp cover may become loose and require reinstallation. Follow directions above.

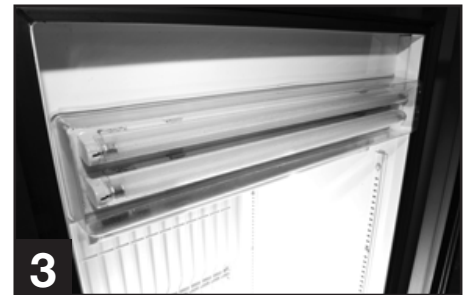
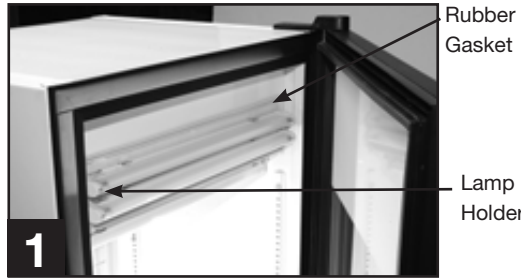

MAINTENANCE, CARE & CLEANING

MAINTENANCE, CARE & CLEANING

CLEANING THE CONDENSER COIL

When using electrical appliances, basic safety precautions should be followed, including the following:

REQUIRED TOOLS:

- Phillips Screwdriver
- Stiff Bristle Brush
- Adjustable Wrench
- Air Tank or CO2 Tank
- Vacuum Cleaner

STEP 1

Disconnect power to unit.

STEP 2

SLIDE DOOR MODELS: Remove louver grill by removing Phillips screw located on either side of the louver grill. (See image 1). Pull the louver grill out from the cabinet front. (See image 2). (To reinstall grill, place louver grill back into brackets located at the base of the unit (See image 3). Snap top of louver grill into place. Replace screws).

SWING DOOR MODELS:

Take off lower grill assembly by removing four (4) screws. (See images 4 & 5.)

STEP 3

Remove bolts anchoring compressor assembly to frame rails and carefully slide out. (tube connections are flexible).

STEP 4

Clean off accumulated dirt from the condenser coil and the fan with a stiff bristle brush.

STEP 5

Lift cardboard cover above fan at plastic plugs and carefully clean condenser coil and fan blades.

STEP 6

INDOOR LOCATION: After brushing condenser coil vacuum dirt from coil, and interior floor. (See Illustration 3).

OUTDOOR LOCATION:

(GDM-33, GDM-47, and GDM-49 only) After brushing condenser coil blow CO2 through condenser from fin side to fan. (See Illustration 4.)

STEP 7

Replace cardboard cover. Carefully slide compressor assembly back into position and replace bolts.

STEP 8

Reinstall louver assembly onto unit with appropriate fastener and clips. Tighten all screws.

STEP 9

Connect unit to power and check to see if compressor is running.

Slide Door Models

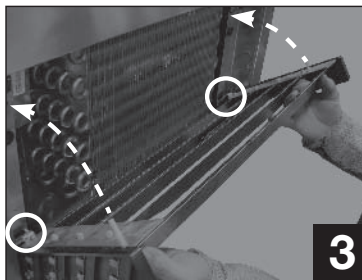
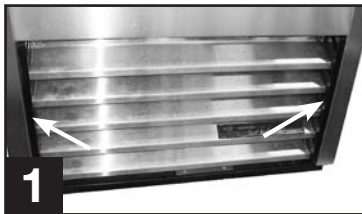

Swing Door Models

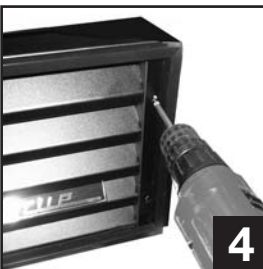

Loosen but do not remove 4 Phillips screws inside the grill frame.



Lift the grill up until it clears the screw key hole slots.

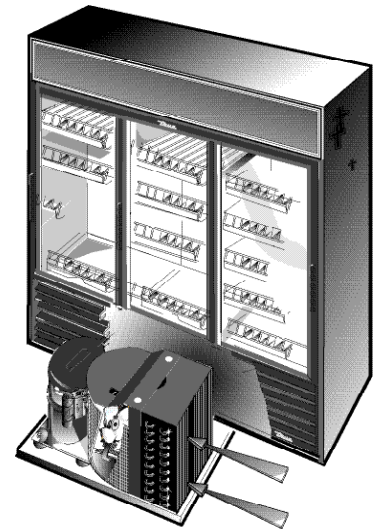

Illustration 3.

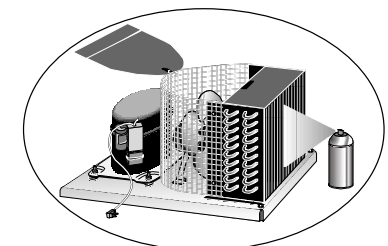
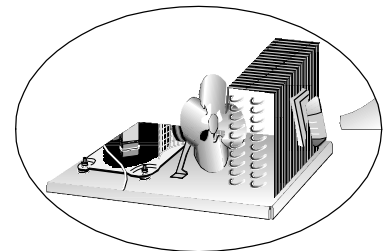

Illustration 4.

MAINTENANCE, CARE & CLEANING

IMPORTANT WARRANTY INFORMATION

Condensers accumulate dirt and require cleaning every 30 days. Dirty condensers result in compressor failure, product loss, and lost sales... which are not covered by warranty.

If you keep the Condenser clean you will minimize your service expense and lower your electrical costs. The Condenser requires scheduled cleaning every thirty days or as needed.

Air is pulled through the Condenser continuously, along with dust, lint, grease, etc.

A dirty Condenser can result in NON-WARRANTEED part & Compressor Failures, Product Loss, and Lost Sales.

Proper cleaning involves removing dust from the Condenser. By using a soft brush, or vacuuming the Condenser with a shop vac, or using CO2, nitrogen, or pressurized air.

If you cannot remove the dirt adequately, please call your refrigeration service company.

On most of the units the condenser is accessible in the rear of the unit. You must remove the cabinet grill to expose the Condenser.

The Condenser looks like a group of vertical fins. You need to be able to see through the condenser for the unit to function at maximum capacity. Do not place filter material in front of condensing coil. This material blocks air-flow to the coil similar to having a dirty coil.

THE CLEANING OF THE CONDENSER IS NOT COVERED BY THE WARRANTY!

HOW TO CLEAN THE CONDENSER:

- 1. Disconnect the electrical power to the unit.**
- 2. Remove the louvered grill.**
- 3. Vacuum or brush the dirt, lint, or debris from the finned condenser coil.**
- 4. If you have a significant dirt build up you can blow out the condenser with compressed air. (CAUTION MUST BE USED to avoid eye injury. Eye protection is recommended.)**
- 5. When finished be sure to replace the louvered grill. The grill protects the condenser.**
- 6. Reconnect the electrical power to the unit.**

If you have any questions, please call TRUE Manufacturing at 636-240-2400 or 800-325-6152 and ask for the Service Department. Service Department Availability Monday-Friday 7:30 a.m. to 6:00 p.m. and Saturday 8:00 a.m. to 12:00 p.m. CST.

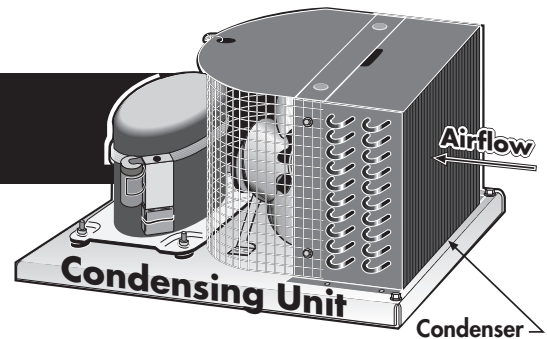

MAINTENANCE, CARE & CLEANING

STAINLESS STEEL EQUIPMENT CARE AND CLEANING

CAUTION: Do not use any steel wool, abrasive or chlorine based products to clean stainless steel surfaces.

• Stainless Steel Opponents

There are three basic things which can break down your stainless steel's passivity layer and allow corrosion to rear its ugly head.

- 1) Scratches from wire brushes, scrapers, and steel pads are just a few examples of items that can be abrasive to stainless steel's surface.
- 2) Deposits left on your stainless steel can leave spots. You may have hard or soft water depending on what part of the country you live in. Hard water can leave spots. Hard water that is heated can leave deposits if left to sit too long. These deposits can cause the passive layer to break down and rust your stainless steel. All deposits left from food prep or service should be removed as soon as possible.
- 3) Chlorides are present in table salt, food, and water. Household and industrial cleaners are the worst type of chlorides to use.

8 steps that can help prevent rust on stainless steel:

1. Using the correct cleaning tools
Use non-abrasive tools when cleaning your stainless steel products. The stainless steel's passive layer will not be harmed by soft cloths and plastic scouring pads. Step 2 tells you how to find the polishing marks.
2. Cleaning along the polish lines
Polishing lines or "grain" are visible on some stainless steels. Always scrub parallel to visible lines on some stainless steels. Use a plastic scouring pad or soft cloth when you cannot see the grain.
3. Use alkaline, alkaline chlorinated or non-chloride containing cleaners
While many traditional cleaners are loaded with chlorides, the industry is providing an ever increasing choice of non-chloride cleaners. If you are not sure of your cleaner's chloride content contact your cleaner supplier. If they tell you that your present cleaner contains chlorides, ask if they have an alternative. Avoid cleaners containing quaternary salts as they can attack stainless steel, causing pitting and rusting.
4. Water Treatment
To reduce deposits, soften the hard water when possible. Installation of certain filters can remove corrosive and distasteful elements. Salts in a properly maintained water softener can be to your advantage. Contact a treatment specialist if you are not sure of the proper water treatment.
5. Maintaining the cleanliness of your food equipment
Use cleaners at recommended strength (alkaline, alkaline chlorinated or non-chloride). Avoid build-up of hard stains by cleaning frequently. When boiling water with your stainless steel equipment, the single most likely cause of damage is chlorides in the water. Heating any cleaners containing chlorides will have the same damaging effects.
6. Rinse
When using chlorinated cleaners you must rinse and wipe dry immediately. It is better to wipe standing cleaning agents and water as soon as possible. Allow the stainless steel equipment to air dry. Oxygen helps maintain the passivity film on stainless steel.
7. Hydrochloric acid (muriatic acid) should never be used on stainless steel
8. Regularly restore/passivate stainless steel

MAINTENANCE, CARE & CLEANING

STAINLESS STEEL EQUIPMENT CARE AND CLEANING

Recommended cleaners for certain situations / environments of stainless steel

- A) Soap, ammonia and detergent medallion applied with a cloth or sponge can be used for routine cleaning.
- B) Arcal 20, Lac-O-Nu Ecoshine applied provides barrier film for fingerprints and smears.
- C) Cameo, Talc, Zud First Impression is applied by rubbing in the direction of the polished lines for stubborn stains and discoloring.
- D) Easy-off and De-Grease It oven aid are excellent for removals on all finishes for grease-fatty acids, blood and burnt-on foods.
- E) Any good commercial detergent can be applied with a sponge or cloth to remove grease and oil.
- F) Benefit, Super Sheen, Sheila Shine are good for restoration / passivation.

NOTE:
The use of stainless steel cleaners or other such solvents is not recommended on plastic parts. Warm soap and water will suffice.

LIGHT BULB REPLACEMENT

IDL (Integrated Door Lighting)

WARNING

Disconnect power to cabinet before replacing light bulbs.

IDL (Integrated Door Lighting):

- Squeeze the plastic lampshield together and pull away from the door (See Image 1).
- Push the bulb down while pulling the spring activated lampholder up. This will give you enough clearance to take the bulb out (See Image 2).



IDL (Integrated Door Lighting)



IDL (Integrated Door Lighting)

WARRANTY INFORMATION (U.S.A & CANADA ONLY!)

**THIS WARRANTY ONLY APPLIES TO UNITS SHIPPED FROM TRUE'S MANUFACTURING FACILITIES AFTER JANUARY 1, 2013.
PRODUCT MUST BE PURCHASED IN THE COUNTRY WHERE SERVICE IS REQUESTED.**

THREE YEAR PARTS & LABOR WARRANTY

TRUE warrants to the original purchaser of every new TRUE refrigerated unit, the cabinet and all parts thereof, to be free from defects in material or workmanship, under normal and proper use and maintenance service as specified by TRUE and upon proper installation and start-up in accordance with the instruction packet supplied with each TRUE unit. TRUE's obligation under this warranty is limited to a period of three (3) years from the date of original installation or 39 months after shipment date from TRUE, whichever occurs first.

Any part covered under this warranty that are determined by TRUE to have been defective within three (3) years of original installation or thirty-nine (39) months after shipment date from manufacturer, whichever occurs first, is limited to the repair or replacement, including labor charges, of defective parts or assemblies. The labor warranty shall include standard straight time labor charges only and reasonable travel time, as determined by TRUE.

Warranty does not cover standard wear parts which include door gaskets, incandescent bulbs or fluorescent bulbs. Warranty also does not cover issues caused by improper installation or lack of basic preventative maintenance which includes regular cleaning of condenser coils.

ADDITIONAL TWO YEAR COMPRESSOR WARRANTY

In addition to the Three (3) year warranty stated above, TRUE warrants its hermetically and semi-hermetically sealed compressor to be free from defects in both material and workmanship under normal and proper use and maintenance service for a period of two (2) additional years from the date of original installation but not to exceed five (5) years and three (3) months after shipment from the manufacturer.

Compressors determined by TRUE to have been defective within this extended time period will, at TRUE's option, be either repaired or replaced with a compressor or compressor parts of similar design and capacity.

The two (2) year extended compressor warranty applies only to hermetically and semi-hermetically sealed parts of the compressor and does not apply to any other parts or components, including, but not limited to: cabinet, paint finish, temperature control, refrigerant, metering device, driers, motor starting equipment, fan assembly or any other electrical component, etcetera.

404A/134A COMPRESSOR WARRANTY

The two year compressor warranty detailed above will be voided if the following procedure is not carefully adhered to:

1. This system contains R404A or R134A refrigerant and polyol ester lubricant. The polyol ester lubricant has rapid moisture absorbing qualities. If long exposure to the ambient conditions occur, the lubricant must be removed and replaced with new. For oil amounts and specifications please call TRUE technical service department (800-325-6152). Failure to comply with recommended lubricant specification will void the compressor warranty.

2. Drier replacement is very important and must be changed when a system is opened for servicing. A drier using XH-7 desiccant or an exact replacement solid core drier must be used. The new drier must also be the same capacity as the drier being replaced.

3. Micron level vacuums must be achieved to insure low moisture levels in the system. 500 microns or lower must be obtained.

WARRANTY CLAIMS

All claims for labor or parts must be made directly through TRUE. All claims should include: model number of the unit, the serial number of the cabinet, proof of purchase, date of installation, and all pertinent information supporting the existence of the alleged defect.

In case of warranty compressor, the compressor model tag must be returned to TRUE along with above listed information.

Any action or breach of these warranty provisions must be commenced within one (1) year after that cause of action has occurred.

WHAT IS NOT COVERED BY THIS WARRANTY

TRUE's sole obligation under this warranty is limited to either repair or replacement of parts, subject to the additional limitations below. This warranty neither assumes nor authorizes any person to assume obligations other than those expressly covered by this warranty.

NO CONSEQUENTIAL DAMAGES. TRUE IS NOT RESPONSIBLE FOR ECONOMIC LOSS; PROFIT LOSS; OR SPECIAL, INDIRECT, OR CONSEQUENTIAL DAMAGES, INCLUDING WITHOUT LIMITATION, LOSSES OR DAMAGES ARISING FROM FOOD OR PRODUCT SPOILAGE CLAIMS WHETHER OR NOT ON ACCOUNT OF REFRIGERATION FAILURE.

WARRANTY IS NOT TRANSFERABLE. This warranty is not assignable and applies only in favor of the original purchaser/user to whom delivered. ANY SUCH ASSIGNMENT OR TRANSFER SHALL VOID THE WARRANTIES HEREIN MADE AND SHALL VOID ALL WARRANTIES, EXPRESS OR IMPLIED, INCLUDING ANY WARRANTY OF MERCHANTABILITY OR FITNESS FOR A PARTICULAR PURPOSE.

IMPROPER USAGE. TRUE ASSUMES NO LIABILITY FOR PARTS OR LABOR COVERAGE FOR COMPONENT FAILURE OR OTHER DAMAGES RESULTING FROM IMPROPER USAGE OR INSTALLATION OR FAILURE TO CLEAN AND/OR MAINTAIN PRODUCT AS SET FORTH IN THE WARRANTY PACKET PROVIDED WITH THE UNIT.

RESIDENTIAL APPLICATIONS: TRUE assumes no liability for parts or labor coverage for component failure or other damages resulting from installation in non-commercial or residential applications.

ALTERATION, NEGLIGENCE, ABUSE, MISUSE, ACCIDENT, DAMAGE DURING TRANSIT OR INSTALLATION, FIRE, FLOOD, ACTS OF GOD. TRUE is not responsible for the repair or replacement of any parts that TRUE determines have been subjected after the date of manufacture to alteration, neglect, abuse, misuse, accident, damage during transit or installation, fire, flood, or act of God.

IMPROPER ELECTRICAL CONNECTIONS. TRUE IS NOT RESPONSIBLE FOR THE REPAIR OR REPLACEMENT OF FAILED OR DAMAGED COMPONENTS RESULTING FROM INCORRECT SUPPLY VOLTAGE, THE USE OF EXTENSION CORDS, LOW VOLTAGE, OR UNSTABLE SUPPLY VOLTAGE.

NO IMPLIED WARRANTY OF MERCHANTABILITY OR FITNESS FOR A PARTICULAR PURPOSE: THERE ARE NO OTHER WARRANTIES, EXPRESSED, IMPLIED OR STATUTORY, EXCEPT THE THREE (3) YEAR PARTS & LABOR WARRANTY AND THE ADDITIONAL TWO (2) YEAR COMPRESSOR WARRANTY AS DESCRIBED ABOVE. THESE WARRANTIES ARE EXCLUSIVE AND IN LIEU OF ALL OTHER WARRANTIES, INCLUDING IMPLIED WARRANTY AND MERCHANTABILITY OR FITNESS FOR A PARTICULAR PURPOSE. THERE ARE NO WARRANTIES WHICH EXTEND BEYOND THE DESCRIPTION ON THE FACE HEREOF.

OUTSIDE U.S./CANADA: This warranty does not apply to, and TRUE is not responsible for, any warranty claims made on products sold or used outside the United States or Canada.