

# Upright Reach-Ins

## Bottom Mounted Condensing Unit

### Owner's Manual

EBR1 EBWR1 EBWRH2 EBNR2  
EBSR2 EBR2 EBR3 EBR1D  
EBNR2D EBR2D EBF1 EBWF1  
EBWFH2 EBNF2 EBSF2 EBF2  
EBF3 EBF1D EBF2D EBWRFH2  
EBSRF2 EBRF2 EBRF2D EBRF3  
EBGR1 EBGR2 EBGR2



REFRIGERATION  
**EVEREST**

[www.everestref.com](http://www.everestref.com)

THIS PAGE INTENTIONALLY LEFT BLANK

# Upright Reach-Ins

## Bottom Mount Condensing Unit

EBR1 EBWR1 EBWRH2 EBNR2 EBSR2 EBR2 EBR3 EBR1D EBNR2D  
EBR2D EBF1 EBWF1 EBWFH2 EBNF2 EBSF2 EBF2 EBF3 EBF1D  
EBF2D EBWRFH2 EBSRF2 EBRF2 EBRF2D EBRF3 EBGR1 EBGNR2 EBGR2



## Contents

1. Hydrocarbon Guidelines	<b>1</b>
2. Installation Instructions	<b>3</b>
3. General Safety	<b>7</b>
4. Electrical Safety	<b>8</b>
5. Operation	<b>9</b>
6. Care and Maintenance	<b>14</b>
7. Door Reversal Instructions	<b>17</b>
8. Troubleshooting Guide	<b>19</b>
9. Warranty Information	<b>21</b>



# 1. Hydrocarbon Guidelines

This section applies to R290 Hydrocarbon units only. To identify the refrigerant type, see the data plate in the cabinet interior.

---

**WARNING** - THIS UNIT USES R290, A HYDROCARBON, PROPANE REFRIGERANT THAT IS ENVIRONMENTALLY FRIENDLY BUT IS ALSO HIGHLY FLAMMABLE AND EXPLOSIVE. PLEASE READ THIS MANUAL CAREFULLY AND FOLLOW ALL SAFETY PRECAUTIONS CONTAINED HEREIN TO AVOID THE RISK OF FIRE OR EXPLOSION. FAILURE TO FOLLOW THE SAFETY PRECAUTIONS MAY RESULT IN SERIOUS INJURY OR DEATH, AND/OR PROPERTY DAMAGE.

**DANGER** - Risk of fire or explosion. Flammable refrigerant used. Do not use mechanical devices or other means to accelerate the defrosting process. Do not puncture refrigerant tubing.

**DANGER** - Risk of fire or explosion. Flammable refrigerant used. To be repaired only by trained service personnel. Do not puncture refrigerant tubing.

**CAUTION** - Risk of fire or explosion. Flammable refrigerant used. Consult Service Manual or Owner's Manual before attempting to install or service this product. All safety precautions must be followed.

**DANGER** - Risk of fire or explosion. Dispose of properly in accordance with federal or local regulations. Flammable refrigerant used.

**DANGER** - Risk of fire or explosion due to puncture of refrigerant tubing; follow handling instructions carefully. Flammable refrigerant used.



Propane (R290) is highly approved for use as a refrigerant in commercial, self-contained units in the US under limited use conditions. It can only be used in new equipment. Backfitting or modifications of old equipment are not allowed. It must be charged in a strictly limited volume of up to 150 grams (5.3 oz) per refrigeration circuit. Even though this is a small amount, it still presents a fire or explosion hazard if it leaks out of parts that hold refrigerant. When it comes in contact with air, a flammable propane-air mixture can be created and easily ignited by electrical sparks, open flames or hot surfaces. The risk is higher in small, confined, poorly ventilated spaces. Propane will settle at lower zones because it is heavier than air. To reduce these risks, observe the following precautions

- Avoid installation of unit in areas with open flames or in general vicinity of open flames or high surface temperatures.
- Avoid unit installation in small, confined spaces. Ensure ample ventilation at all times. Keep all exhaust vents free of any blockage or obstruction.
- Do not rely on smell to detect potential leaks of propane refrigerant. Propane refrigerant is a high purity propane gas and does not contain odourants or stenching agents. These additives are typically used in fuel-grade propane and natural gas in order to give them a distinctive smell which makes it easier to detect leaks.
- General service and repairs must be performed in well-ventilated areas. General service and repairs must be performed only by professionals authorized by Everest Refrigeration.
- Component shall be replaced with Everest-issued, like components to minimize the risk of possible ignition resulting from incompatible parts or improper repairs.
- Do not modify, re-appropriate or remove any functional part(s) from the unit.
- Handle the unit with care to avoid any damage.
- Practice safety guidelines when transporting the unit. Consult with your local Department of Transportation for requirements in moving flammable gasses.

## 2. Installation Instructions

**This section applies to all Everest products. Correct installation ensures proper performance and longevity of your appliance. Professional installation by a trained refrigeration technician and electrician is recommended. Warranty is void if the following guidelines are not met.**

---

- 1.** Inspect for any freight damage upon delivery of the unit. If damage is detected, immediately report it to an Everest representative. Everest is not responsible for damage that occurs during shipment.
- 2.** Keep the unit upright at all times. The compressor contains oil, refrigerant, lubricants and various chemicals. When tilted, these fluids may shift and travel to sections where they don't naturally occur. This will lead to system contamination and compressor failure.
- 3.** Some units require caster installation for proper performance. Visit our website at [www.everestref.com](http://www.everestref.com) and enter your product's model number in the search field to determine its caster requirements.
- 4.** Do not place your hands under the unit when moving it to avoid injury from sharp edges, protruding parts or weight impact.
- 5.** Select a location with good air ventilation. Poor ventilation rapidly increases ambient temperature. High ambient temperatures exceeding 86°F (30°C) promote excessive compressor activity in order to maintain the desired cabinet temperature. This will result in decreased performance, advanced component failure and the risk of fire.
- 6.** Select a location away from heat-generating equipment such as stoves, ovens, etc. Heat sources rapidly increase the temperature of the immediate vicinity. High temperatures exceeding 86°F (30°C) promote excessive compressor activity in order to maintain the desired cabinet temperature. This will result in decreased performance, advanced component failure and the risk of fire.
- 7.** A distance of 6" is required for backside clearance. This ensures proper ventilation and prevents overheating which can lead to advanced component failure and the risk of fire.
- 8.** Select a location with a hard, leveled surface. Use a leveling tool on the unit to ensure a proper alignment. Proper door function and condensate removal is dependent on accurate balance.
- 9.** Select a location close to an electrical wall outlet to ensure direct connection without the use of extension cords.
- 10.** Select a location away from severe moisture conditions. This may compromise the unit's electrical components and lead to electrical shocks or the risk of fire.
- 11.** Select a location that will not expose the unit to extremely dusty conditions. Environments with high dust and debris content will significantly hasten condenser coil blockage and will result in decreased performance, advanced component failure and the risk of fire.
- 12.** Do not build an enclosure or cabinet around the unit. This will restrict air ventilation resulting in elevated compressor activity, decreased performance, advanced component failure and the risk of fire.
- 13.** The unit is not intended for use in food trucks. Limited space, lack of ventilation and ambient temperatures exceeding 86°F (30°C) typical to this setting will result in elevated compressor activity, decreased performance, advanced component failure and the risk of fire.
- 14.** The unit is intended for indoor use only. Outdoor use will cause a decrease in performance, advanced component failure and the risk of fire.

# Shelf Installation

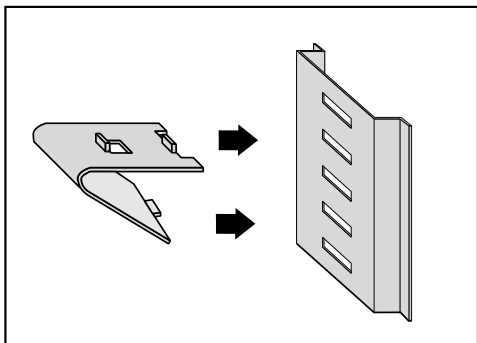

**Some units come standard with shelves, shelf clips and notched pilasters. Each shelf requires four clips.**

Attach the shelf clips onto the pilasters by inserting its top hook into a pilaster notch followed by the bottom hook. Do not use pliers or other crimping tools to modify the shape of the shelf clips. This will result in shelf mounting instability.

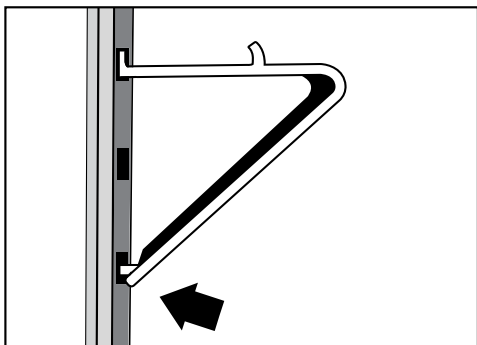
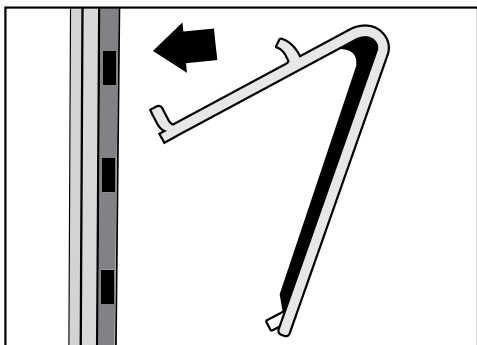

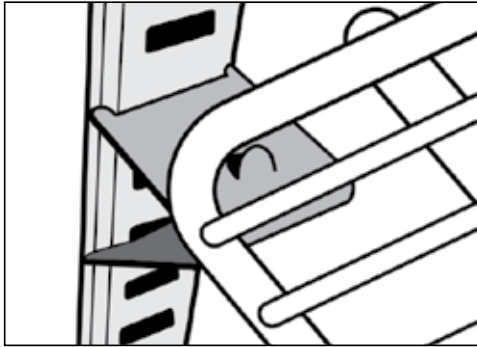
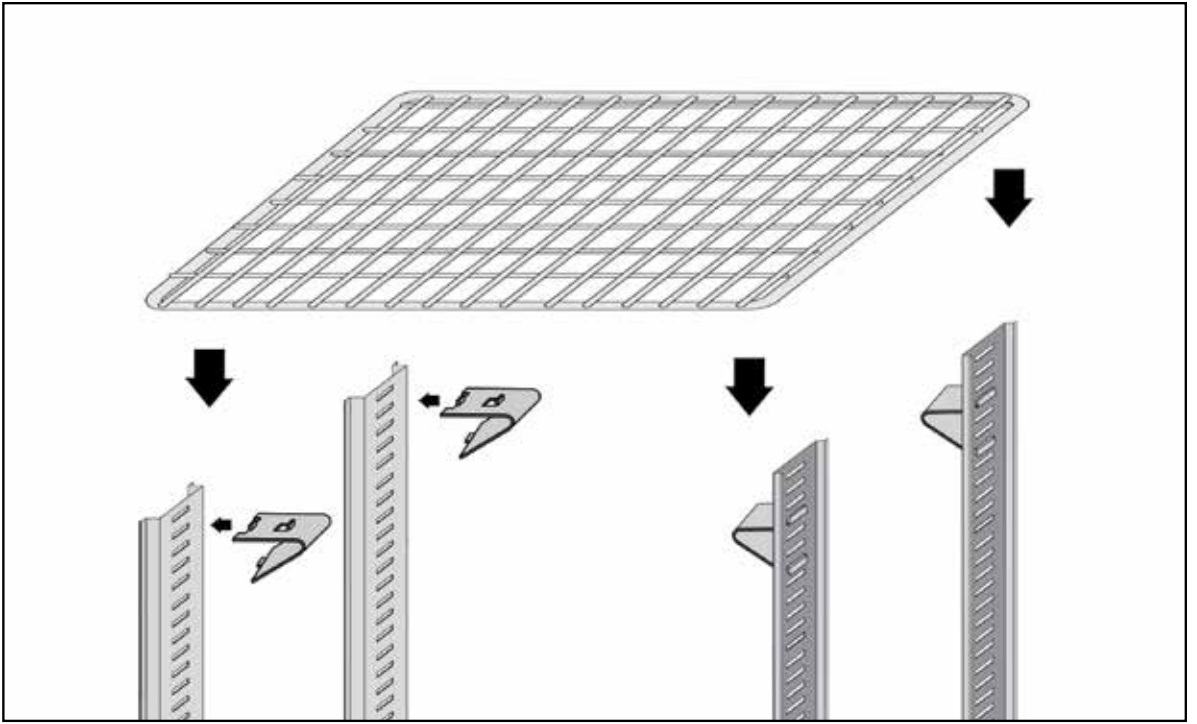

Place shelves on the shelf clips making sure all corners are mounted securely and evenly with identical distance from the unit's floor and up. Always lay the back of each shelf down on the rear clips before the front.

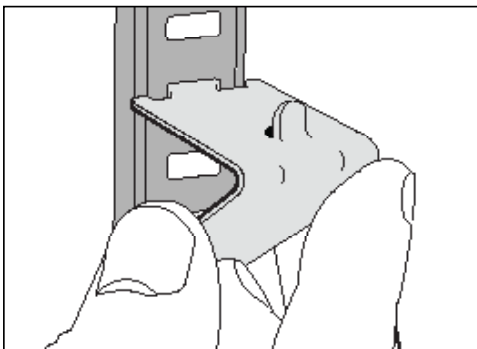

When removing a shelf, unmount the shelf from the shelf clips. To detach the shelf clip from the pilaster, tilt up the shelf clip until the bottom hook clears followed by the top hook.



# Product Load Level & Shelf Placement

EB Series

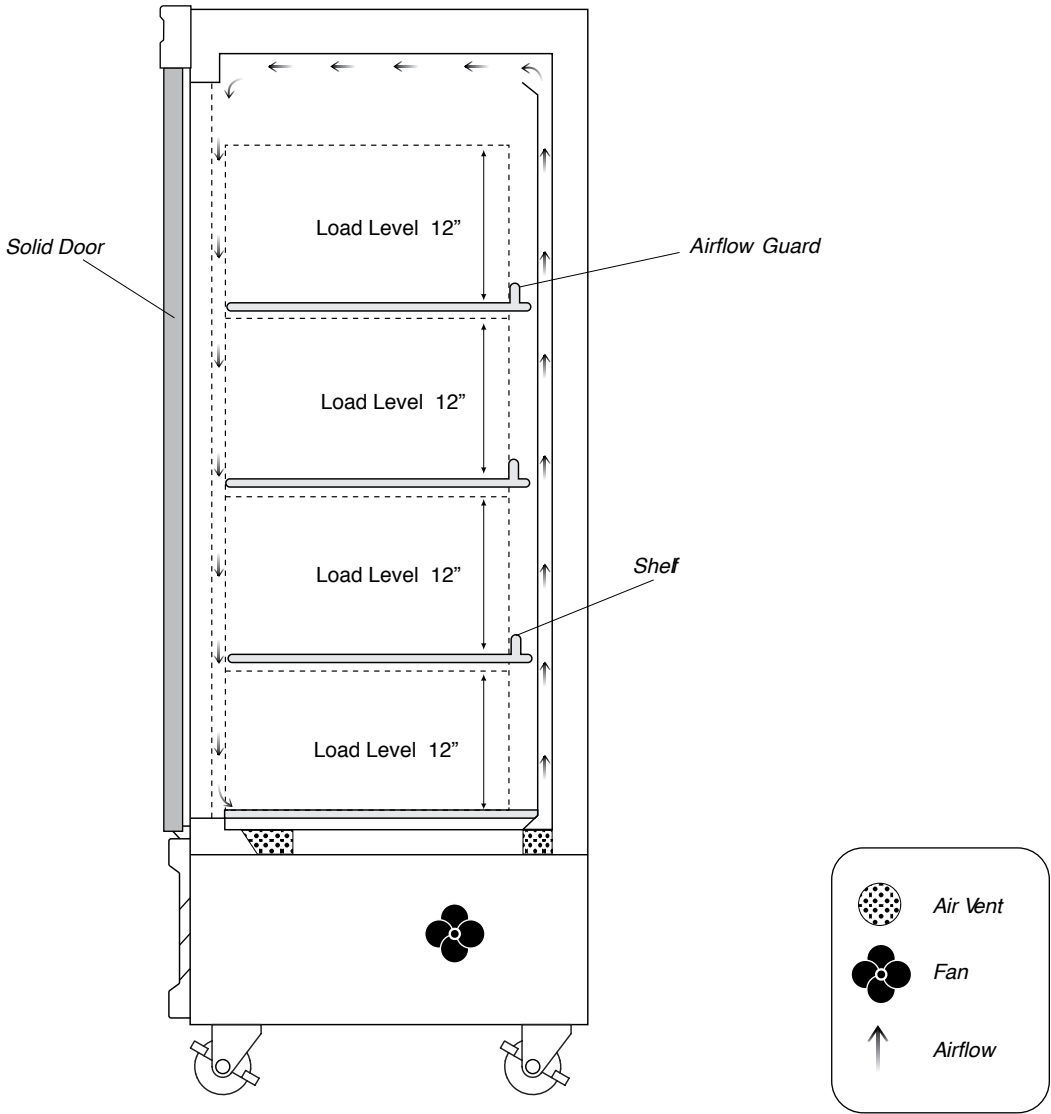

Side View

← Front

→ Rear

### 3. General Safety

**This section applies to all Everest products. Use your appliance according to its designed function as specified in this Owner's Manual. Warranty is void if the following guidelines are not met.**

---

- Before the unit is used, it must be installed and connected according to the installation instructions provided in this manual.
- Remove all packaging material and protective vinyl covering from the unit before it is used. These items are flammable and can lead to a fire.
- Do not store or use gasoline or other flammable vapors and liquids in the vicinity of the unit. Do not store combustible or explosive items and substances such as aerosol cans in or around the vicinity of the unit.
- Do not place objects on or around the exhaust vents of the unit. This can cause overheating which may lead to a fire or explosion. Objects may also fall when opening and closing doors which may lead to serious injury.
- Do not climb, stand or hang on the shelves, doors or drawers of the unit. This can damage the unit and lead to serious injury.
- Do not touch the freezer interior if your hands are wet or damp. This may lead to freezer burn or cause your skin to stick to the cold surface.
- If you suspect a refrigerant leak or a compromised refrigeration system, disconnect the unit and contact Everest Refrigeration immediately.
- When disposing the unit, remove all doors and shelves to avoid any risk of injury or entrapment. Ensure that the refrigerant in the condensing unit is properly disposed of by a qualified refrigeration technician according to governmental codes, requirements and regulations.



## 4. Electrical Safety

**This section applies to all Everest products. Basic safety precautions must be observed when using electrical appliances in addition to the following. Warranty is void if these guidelines are not met.**

Everest units come as 115 volts, 60 hertz, single phase.

Everest units are equipped with a NEMA 5-15P plug except for models ESF2, ESWF2, ESF3 and EBF3 which are equipped with a NEMA 5-20P. A 15 amp breaker must be used for units that come with a NEMA 5-15P plug. A 20 amp breaker must be used for units that come with a NEMA 5-20P plug.



**115/60/1  
NEMA 5-15R**



**115/60/1  
NEMA 5-20R**

The ground prong must not be removed to reduce the risk of electric shock and related hazards. If the grounding pin is missing, the cord must be removed from use. If the outlet is a standard 2-prong outlet, it must be replaced with the properly grounded 3-prong wall outlet. Only a qualified electrician may install the correct power source.

To guarantee electrical safety, the wall outlet and circuit must be checked by a qualified electrician to make sure it is properly grounded.

Remove debris from the power plug prongs with a soft cloth or brush before connecting it to an outlet.

Assign the unit to a dedicated, undamaged electrical circuit with a voltage rating that matches the data plate. Check the incoming voltage with a multi-meter. This avoids the overloading and overheating of circuit wires which may lead to a fire.

Do not use extension cords, adapter plugs or other third party electrical connections. Everest is not responsible for issues resulting from improper electrical connections, electrical power failures and voltage fluctuations.

Everest does not recommend the use of generators in conjunction with the unit due to voltage fluctuations that may compromise electrical components.

Turn off the unit using the power button before unplugging. Wait at least 5 minutes before re-plugging to prevent damage to the compressor.



Do not unplug the unit by tugging on the power cord. Grip the plug and pull it securely out of the outlet.

Prevent damage to the power cord by providing sufficient clearance around and under the unit. Do not use a power cord that shows cracks or exposed wires. Power cords that have been severely worn or damaged must be replaced with original manufacturer parts and only by an authorized technician.

# 5. Operation

**This section applies to all Everest products. Use according to the described and intended functions. Warranty is void if these guidelines are not met.**

## Starting your Everest Product

After plugging in the unit, the current temperature and compressor symbol  will appear on the digital temperature control's LED display  will flash at short intervals for 1 minute after which the compressor(s) and condenser fan motor(s) will initiate. At the beginning of every compressor cycle, the condenser fan motor is automated to rotate in reverse for 30 seconds in order to blow dust off the condenser coil.

The evaporator fan motor(s) will initiate once the evaporator coil reaches a specific temperature relative to the digital temperature control setting and for as long as the door is closed. A fan symbol  will appear on the LED display to indicate that the evaporator fan is running.

Allow the unit to operate for 24 to 72 hours before storing contents in the cabinet. This lets the cabinet temperature fully stabilize. Use this time to verify proper installation and operation.

The interior light and evaporator fan motor is controlled by a door switch for solid door models and a rocker switch for glass door models.

The default temperature setting is 35.0°F (2.0°C) for refrigerators and -4.0°F (-20.0°C) for freezers. The factory recommended temperature range is between 33.0°F (1.0°C) to 40.0°F (4.0°C) for refrigerators and -5.0°F (-21.0°C) to 0°F (-18.0°C) for freezers. Setting the temperature outside of the recommended range will cause performance issues and in some cases may result in component failure that is outside of warranty coverage.

The compressor, condenser and evaporator fan motors run while the unit is on refrigeration cycle.

The compressor, condenser and evaporator fan motors stop running while the unit is on defrost cycle.

The unit is preset to defrost every 5-6 hours with a duration of 45 minutes or less depending on the evaporator coil temperature. Changing the preset outside of the default range will result in cooling issues and advanced component failure.

The digital temperature control is intended to read and display the cabinet's air temperature, not actual food product temperature. The displayed temperature may fluctuate due to frequent or prolonged door operation. The most conclusive method to determine a unit's cooling performance is to measure the food product's temperature using a digital food thermometer.

# Carel 'Easy' Digital Temperature Control

Everest units are equipped with a Carel Digital Temperature Control. The type of controller is dependent on the model and production date.

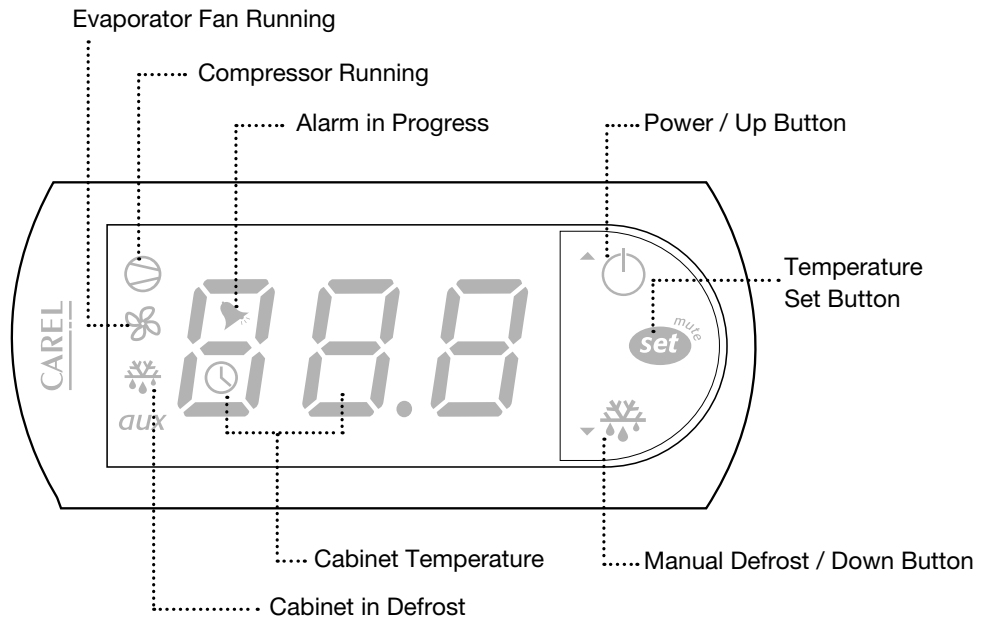

## Setting the Temperature



1. Press and hold Temperature Set Button **set** for 2 seconds until the LED blinks SET **88.8** alternating with a number. The blinking number is the current set temperature.

**CAUTION:** If PS appears on the LED



This means the Temperature Set button **set** was held down longer than 3 seconds. To exit this mode and restart, press Temperature Set Button **set**

## Setting the Temperature ( continued )

2. Toggle through the desired temperature by pressing UP  or DOWN . The number increases or decreases by a decimal point.

3. The recommended setting is 35.0°F (2.0°C) for refrigerators and -4.0°F (-20.0°C) for freezers. The available temperature setting range is 33.0°F to 54.0°F (1.0°C to 12.0°C) for Refrigerators and -10.0°F to 54.0°F (-23.0°C to 12.0°C) for Freezers.

4. Press and hold the Temperature Set Button  for 3 seconds to save the new temperature and exit the setting mode. The LED will return to the current cabinet temperature.

## Initiating Manual Defrost

The controller has an automatic defrost cycle in place so initiating manual defrost is not necessary unless there is an abnormal accumulation of ice around the evaporator coil.

1. Press and hold down the Manual Defrost Button  until the Defrost Symbol  appears on the LED display.

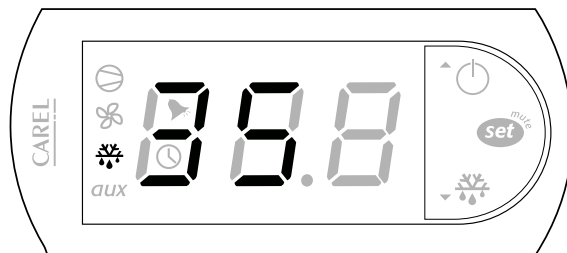

The compressor, condenser and evaporator fan motors will stop running. The refrigeration system will remain in defrost cycle for 45 minutes or until the evaporator coil reaches the safety termination temperature setting.

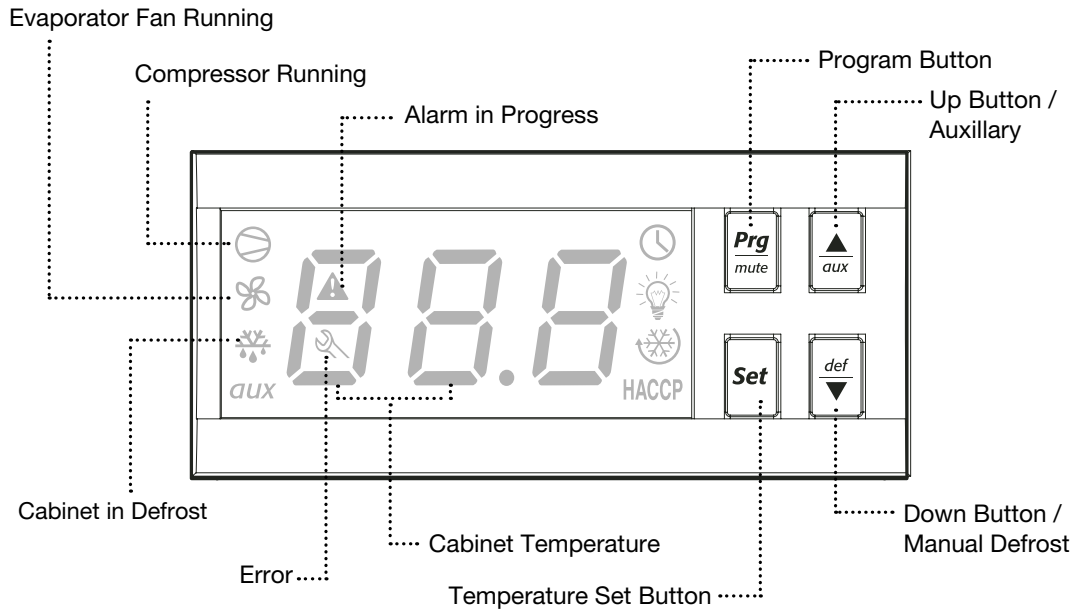

# Carel 'ir33' Digital Temperature Control

Everest units are equipped with a Carel Digital Temperature Control. The type of controller is dependent on the model and production date.



## Setting the Temperature

1. Press and hold Temperature Set Button  for 2 seconds until a number blinks on the LED. The blinking number is the current set temperature.



2. Toggle through the desired temperature by pressing UP  or DOWN . The number increases or decreases by a decimal point.

3. The recommended setting is 35.0°F (2.0°C) for refrigerators and -4.0°F (-20.0°C) for freezers. The available temperature setting range is 33.0°F to 54.0°F (1.0°C to 12.0°C) for Refrigerators and -10.0°F to 54.0°F (-23.0°C to 12.0°C) for Freezers.

4. Press and hold the Temperature Set Button  for 3 seconds to save the new temperature and exit the setting mode. The LED will return to the current cabinet temperature.

## Initiating Manual Defrost

The controller has an automatic defrost cycle in place so initiating manual defrost is not necessary unless there is an abnormal accumulation of ice around the evaporator coil.

1. Press and hold down the Manual Defrost Button  until the Defrost Symbol  appears on the LED display.



The compressor, condenser and evaporator fan motors will stop running. The refrigeration system will remain in defrost cycle for 45 minutes or until the evaporator coil reaches the safety termination temperature setting.



## 6. Care and Maintenance

**This section applies to all Everest products. Regular care and maintenance of your appliance will significantly extend service life and dependability. In severe cases, lack of upkeep will contribute to the rapid decline in performance and component health. Care and maintenance is the product owner's personal responsibility. Warranty is void if these guidelines are not met.**

---

- Unplug the unit before cleaning, repairing or replacing parts.
- Do not spray the unit with water to avoid electric shock, component malfunction or the risk of fire.
- Do not use any flammable cleaning products on or around the unit to prevent the risk of fire.
- Do not use household or industrial chemical cleaners, acidic or chlorine based solutions, degreasers, wire brushes, scrapers, steel pads, acidic solutions, or other abrasive products. These will damage the stainless steel's passivity layer resulting in advanced corrosion.
- The condenser coil and condenser coil air filter build up lint, dust and grease over time and will require monthly cleaning. Clogged condenser coil and filters will result in decreased performance, advanced component failure, and a risk of fire. See [pages 15-16](#) for condenser coil and filter cleaning instructions.
- Conduct regular inspection and cleaning of the door gaskets to ensure that they are sealing completely. Worn out or damaged gaskets will have gaps that will compromise cabinet temperature leading to possible food spoilage or component failure.
- Clean the interior surface of the unit with mild soap and warm water. Do not let water accumulate inside the unit. To prevent water damage, wipe the interior of the unit with a dry cloth as needed. Do not use steel wool, strong acids, concentrated detergents, bleaches, cleaning waxes, polishers and other abrasive cleaners. Avoid contact with electronic parts to avoid the risk of fire.
- Clean the exterior of the product with a stainless steel cleaner to restore the condition and passivation of the stainless steel surface. Do not use steel wool, strong acids, concentrated detergents, bleaches, cleaning waxes, polishers and other abrasive cleaners. Avoid contact with electronic parts to avoid the risk of fire.
- Acidic products and products containing vinegar must be stored in sealed containers to prevent acid damage to the interior of the unit and the evaporator coil. Rust resulting from improper maintenance is not covered under warranty.



# Condenser Coil Cleaning Instructions

*\* R404A freezer models are equipped with a condenser coil air filter. R290 refrigerator models are not equipped with a condenser coil air filter. If your product is an R290 refrigerator model, you may skip this section.*

This section applies to all Everest products. The condenser coil requires monthly cleaning to keep the metal fins clear of lint, dust and grease build-up. A clogged condenser coil severely reduces your product's energy efficiency and places strain on the compressor and other components leading to advanced failure. Cleaning the condenser coil is the product owner's personal responsibility. **Warranty is void if the following guidelines are not met.**

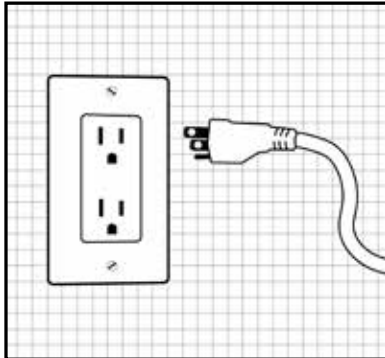

1. Disconnect the unit from the outlet before performing maintenance.

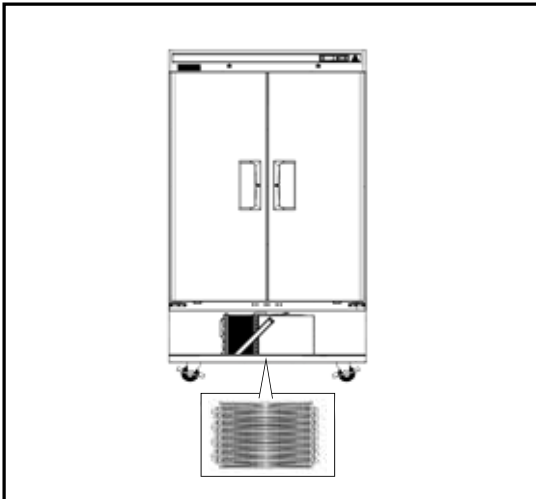

2. Locate the condenser coil at the bottom section of the unit. Some frames do not have panels for ease of access and ventilation purposes.

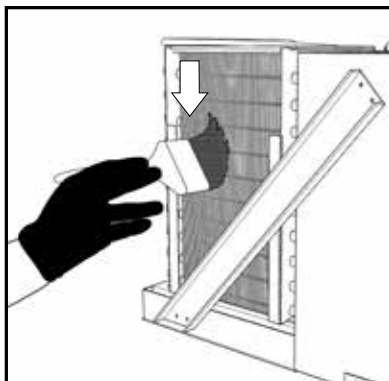

3. Use a long bristled brush in a vertical sweeping motion to remove lint, dust and debris from in between the metal fins of the condenser coil. Do not apply heavy pressure so as not to bend the fins.

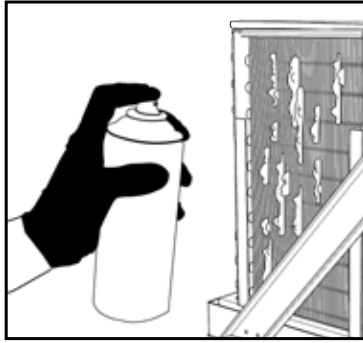

4. Use a commercial condenser coil cleaner for metal fins that are coated in grease. Allow the cleaner to saturate the area. Follow the recommended wait time printed on the product packaging.

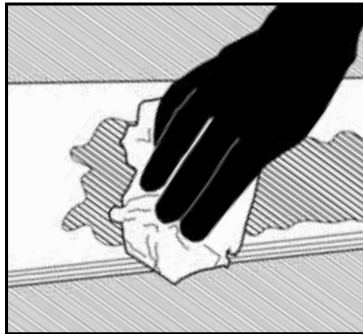

5. The grease and cleaning solvent will pool at the base of the metal fins. Brush the fins and wipe off any accumulated residue.

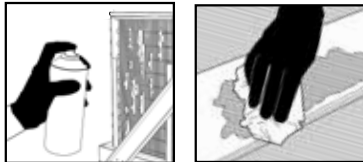

6. Repeat the above steps until the metal fins are clean. You should be able to see in through and in between the metal fins.

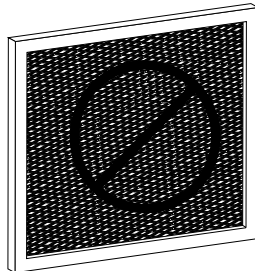

7. Do not attach an aftermarket filter or screen around the condenser coil. This constricts ventilation which leads to overheating, component failure or the risk of fire.

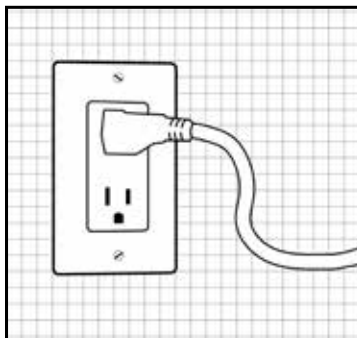

8. Reconnect the unit to the designated outlet.

# 7. Door Reversal Instructions

Some products have field reversible doors to accommodate specific kitchen layouts. Door reversals must be performed by qualified technicians. A second person is required. Safety goggles must be worn to protect from spinning parts. Warranty is void if the following guidelines are not met.

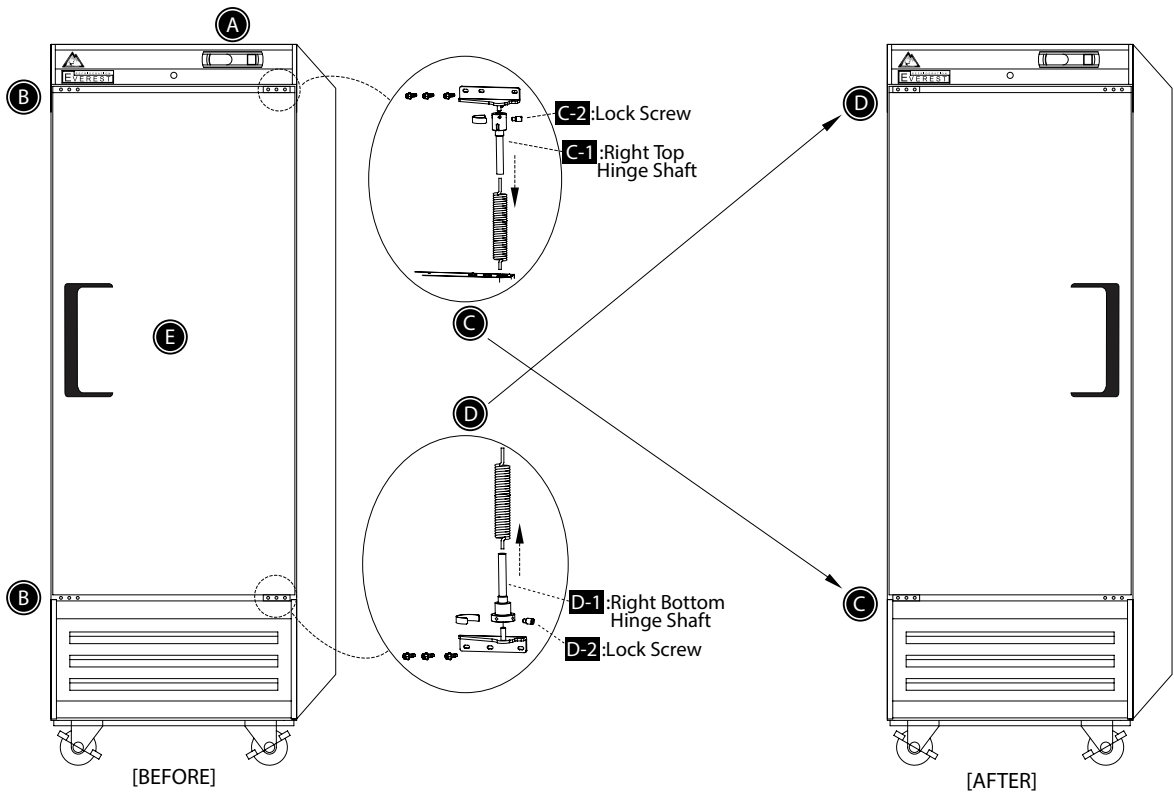

1. The front grill (A) must be opened before reversing the door. Grab the left and right bottom corner of the front grill and pull it towards you. Slightly lift up the front grill until its top hooks unlock from the frame.
2. Locate 3 screws (B) on the top left corner of the door frame and 3 screws (B) on the bottom left corner of the door frame. Remove these screws from the pre-drilled holes. They will be used to mount the door to the left door frame later.
3. Locate the door switch tab on the top right door frame (E). The tab is positioned to press on the door switch that controls the interior lights and evaporator fans. Once the door is reversed, the tab must be moved to the same location.
4. Locate the door spring shaft on the top right corner of the door (C-1). The head of the shaft has 4 screw holes, one of which is occupied by a lock screw that maintains door spring tension (C-2). Remove the half ring shaft cap to expose the remaining vacant screw holes.

- 5.** Extra precaution must be taken for the following steps. Release the door tension from the door spring by inserting a sharp pointed implement into one of the door hinge shaft's unoccupied tension lock screws **C-2**.
- 6.** Slowly turn the door spring shaft clockwise until you are able to unscrew the tension lock screw **C-2**. Remove the tension lock screw.
- 7.** Slowly take out the sharp pointed implement inserted into one of the spring shaft's unoccupied tension lock screw holes. When the rigid object clears the hole, the door spring will release the stored tension and the door spring shaft will spin rapidly.
- 8.** Follow steps 4 through 7 for the bottom door shaft.
- 9.** A second person is required to secure the door against the unit while the top hinge is removed **E**.
- 10.** Detach the top hinge by removing the 3 screws holding it in place **C**.
- 11.** Lift the door until it detaches from the bottom hinge **D**. Ensure that the top and bottom springs and shafts remain in the door cavity.
- 12.** Detach the bottom hinge by removing the 3 screws holding it in place **C**. Detach the bottom hinge.
- 13.** The right top hinge becomes the left bottom hinge **C**. Install the right top hinge into the left bottom position using 3 screws. Ensure that the door hinge pins are facing up.
- 14.** Flip the door so that the hinged corners are on the left side when facing the door **E**.
- 15.** Mount the door on the bottom door hinge **C**. The longer of the two pins pointing upward should be inserted into the bottom spring shaft.
- 16.** A second person is required to secure and hold the door against the unit while the top hinge is installed **E**.
- 17.** The bottom right hinge becomes the left top hinge **D**. Install the left top hinge on the door. The two pins on the door hinge should be facing down and the longer of the two inserted into the top door spring shaft.
- 18.** Secure the top hinge to the unit using 3 screws. Ensure that the door is properly secured to the frame.
- 19.** Sufficient tension must be added to the door springs so that it self-closes. Insert 2 sharp pointed implements into the vacant tension lock screw holes **C-1** **D-1** and turn the shaft counterclockwise. 2 to 3 rotations should provide sufficient tension.
- 20.** Test the door for proper operation.

## 8. Troubleshooting Guide

In most cases, your Everest product may be exhibiting behavior that is typical of standard operation. Observe the following when troubleshooting symptoms.

### **'cht' or 'CHt' appears on the LED alternating with the current temperature and accompanied by an audible alarm.**

The condenser coil may be clogged with dust, grime or debris. Clean them following the instructions in [Chapter 6](#).

The room's ambient temperature may be higher than 86°F (30°C). Provide ample ventilation or additional cooling to the room. Relocate the unit from extremely small spaces without ventilation.

The unit may be installed in close proximity to heat sources such as ovens, stoves, heaters or direct sunlight. Relocate the unit away from these sources.

The unit may be installed without clearance or proper ventilation. Provide additional exhaust vents and observe the clearance allowance specified on [Chapter 2](#).

### **The compressor, fan motors or entire system fails to start**

The ON/OFF switch may be set to OFF. Turn to the ON position and wait for the LED and motors to show signs of operation.

The power cord may not be connected. Ensure the connection. In cases of damage to the power cord or plug, immediately mark the unit as out of order until the damaged part is replaced.

The outlet may not be sending power or the power supply breaker may be switched off. Unplug the unit and contact a licensed electrician for inspection and/or repairs.

### **The compressor operates continuously or for prolonged periods.**

The condenser coil may be clogged with dust, grime or debris. Clean them following the instructions in [Chapter 6](#).

The door or door gaskets may not be sealing properly. Check product placement in the cabinet as it may prevent the door from fully closing. If the gasket is loose, reattach.

The evaporator coil may be blocked with ice. Defrost it following the instructions on page [Chapter 5](#). Normally, evaporator coils will self-maintain with automated defrost cycles. If the evaporator coil ices up frequently, re-assess placement of food items in the cabinet as it could obstruct cold air circulation.

The room's ambient temperature may be higher than 86°F (30°C). Provide ample ventilation or additional cooling to the room. Relocate the unit from extremely small spaces without ventilation.

The unit may be installed in close proximity to heat sources such as ovens, stoves, heaters or direct sunlight. Relocate the unit away from these sources.

The unit may be installed without clearance or proper ventilation. This forces the compressor to operate constantly in order to maintain cabinet temperature. Provide additional exhaust vents and observe the clearance allowance specified on page (15, 16).

**The cabinet temperature is too warm.**

The condenser coil may be clogged with dust, grime or debris. Clean them following the instructions in [Chapter 6](#).

The door or door gasket may not be sealing properly. Check product placement in the cabinet as it may prevent the door from fully closing. If the gasket is loose, reattach.

The temperature may be set too high. Adjust the setting to 35.0°F (2.0°C) for refrigerators or -4.0°F (-20.0°C) for freezers.

Hot food items may have been placed in the cabinet. Store only room temperature food items.

The room's ambient temperature may be higher than 86°F (30°C). Provide ample ventilation or additional cooling to the room. Relocate the unit from extremely small spaces without ventilation.

The unit may be installed in close proximity to heat sources such as ovens, stoves, heaters or direct sunlight. Relocate the unit away from these sources.

The unit may be installed without clearance or proper ventilation. Provide additional exhaust vents and observe the clearance allowance specified on page [Chapter 2](#).

**Food items are frosting over.**

The temperature may be set too low. Adjust the setting to 35.0°F (2.0°C) for refrigerators or -4.0°F (-20.0°C) for freezers.

The placement of food items in the cabinet may be obstructing circulation of refrigerated air. This creates uneven temperature in the cabinet with pockets of very cold air that may cause items to frost or freeze over.

**Condensation in the interior cabinet.**

The door or door gasket may not be sealing properly. Check product placement in the cabinet as it may prevent the door from fully closing. If the gasket is loose, reattach.

Hot food items may have been stored in the cabinet. The interaction between hot and cold temperatures will promote condensation.

Unsealed or open food items with high moisture content may have been stored in the cabinet. Keep these items in air tight containers.

Mild condensation in warmer ambient temperature conditions may occur due to frequent or prolonged door operation.

**Condensation on the unit's exterior surfaces.**

Highly humid environments will contribute to the condensation build up on exterior panels. Providing ample ventilation and air movement to a space will reduce the humidity level.

The door or door gasket may not be sealing properly. Check product placement in the cabinet as it may prevent the door from fully closing. If the gasket is loose, reattach.

**Noise level during unit operation.**

It is normal for commercial grade compressors and components to have a higher decibel output compared to residential counterparts.

The unit may not be balanced evenly. Poorly leveled units may cause components or fittings to misalign or disengage during operation. This may produce noise as a direct result of repeated surface friction or impact.

The unit may not be securely mounted to the floor. This may produce noise as a direct result of repeated surface friction or impact.

Some sounds are normal for the refrigeration process. A dripping sound, for example, is the result of refrigerant circulation during the compressor rest period.

# Warranty Registration

Registering your new appliance is important. In the unlikely event a safety notification or warranty service is required, we will have the means to contact you. Your completed appliance registration also verifies your ownership in the event of an insurance loss or theft.

You may register online at [www.EVERESTref.com](http://www.EVERESTref.com) or use your smart phone to scan the QR code below:

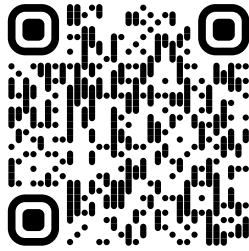

1. Open the camera app.
2. Point the camera at the QR code.
3. Scan and launch the QR code.

## Product Identification:

The product data plate is a permanently affixed label that contains the model, serial, barcode numbers, and refrigeration data of your Everest product. The tag is located on the rear or side of the unit exterior. Please retain this information for warranty-related purposes.



# EVEREST REFRIGERATION

Commercial Refrigerators

MODEL : ESC47L Assembled in Korea

COMPRESSOR : 1/8 HP

REFRIGERANT : R290

\* Use of other than specified refrigerant voids warranty

REFRIGERANT CHARGE : 3.17 Oz

ELECTRICAL : 115VX1Phx60Hz

TOTAL AMPS : 3.27A (COMP RUN)

HIGH PRESSURE TEST : 218PSIG.

LOW PRESSURE TEST : 38PSIG.

\* Do not clean label with solvent

Serial No:  
BTR1XXXXXXXX



ETL LISTED  
CONFORMS TO  
ANSI/UL-471 CERTIFIED TO  
CAN/CSA C22.2 NO. 120



9900932

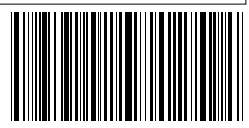

BB1KD0539A



# Warranty Certificate

EVEREST warrants to the first purchaser of every new EVEREST unit, the cabinet and all parts thereof, to be free from defects in material or workmanship, under normal and proper use and maintenance service as specified by EVEREST and upon proper installation and start-up in accordance with the instruction packet supplied with each unit.

## **Three (3) Year Labor & Parts Warranty**

*(for Upright Reach-Ins, Glass Door Merchandisers, Undercounters, Chefbases, Prep. Tables, Bar Equipment and Dry Ager Refrigerated Display Cases)*

EVEREST's obligation under this warranty is limited to a period of three (3)\* years from the date of original installation or thirty-six (36)\* months after shipment date from EVEREST, whichever occurs first. Any part covered under this warranty that is determined by EVEREST to have been defective within three (3)\* years of original installation or thirty six (36)\* months after shipment date from the manufacturer, whichever occurs first, is limited to the repair or replacement, including labor charges, of defective parts or assemblies. The labor warranty shall include standard straight time labor charges and reasonable travel time, as determined by EVEREST.

## **Two (2) Year Labor & Parts Warranty**

*(for Open Air Merchandisers)*

EVEREST's obligation under this warranty is limited to a period of two (2)\* years from the date of original installation or twenty-four (24)\* months after shipment date from EVEREST, whichever occurs first. Any part covered under this warranty that is determined by EVEREST to have been defective within two (2)\* years of original installation or twenty-four (24)\* months after shipment date from the manufacturer, whichever occurs first, is limited to the repair or replacement, including labor charges, of defective parts or assemblies. The labor warranty shall include standard straight time labor charges and reasonable travel time, as determined by EVEREST.

## **Five (5) Year Compressor Warranty**

In addition to the warranty set forth above, EVEREST warrants the hermetically sealed compressor for five (5) years, not to exceed sixty (60) months from the unit's date of shipment from EVEREST.

## **Warranty Claims**

All warranty claims for labor or parts must be made directly through EVEREST. All claims shall include: unit model number, cabinet serial number, proof of new product purchase, installation date, and all pertinent information related to the reported defect. To qualify for a compressor warranty claim, the replacement compressor must have been purchased directly from EVEREST. Claimants must submit the compressor warranty form and compressor tag to EVEREST. The compressor warranty does not apply to shipping and labor costs or other parts whether electrical or mechanical.

## **Warranty Exclusions**

EVEREST's sole obligation under this warranty is limited to either the repair or replacement of parts, subject to the additional limitations below. This warranty neither assumes nor authorizes any person to assume obligations other than those expressly covered by this warranty.

- A. **NON WARRANTY PARTS.** EVEREST excludes specific parts exposed to normal wear and tear. These parts include, but are not limited to, lamps, gaskets, casters, shelves and shelf clips, pans, bin and pan dividers and airflow guards.
- B. **INDIRECT OR CONSEQUENTIAL DAMAGE.** EVEREST does not warrant economic loss, profit loss, or special, indirect or consequential damages including without limitation, losses or damages arising from food or product spoilage claims caused by refrigeration failure.
- C. **IMPROPER USAGE.** EVEREST is not responsible for parts or labor coverage for component failure and or other damages resulting from improper usage, installation or failure to clean and/or maintain the unit as set forth in the user's manual provided with this unit. All EVEREST units are designed for commercial use, not for residential use. Warranty is invalid if the unit is installed in a residence.
- D. **RELOCATION OF UNIT FOR REPAIR.** EVEREST is not responsible for the cost to move a unit for any reason from its position of operation on the customer's premises to make a warranty repair. Further, EVEREST is not responsible for the cost of disassembling cabinetry and/or panels built around the unit to make a warranty repair.
- E. **WARRANTY IS NOT TRANSFERABLE.** Warranty is limited to only the original purchaser, owner or lessee of the unit. Warranty does not transfer with change of ownership or lessee.
- F. **ALTERATION, NEGLIGENCE, MISUSE, ABUSE, ACCIDENT, DAMAGE DURING TRANSIT OR INSTALLATION, FIRE, FLOOD, ACTS OF GOD.** EVEREST is not responsible for malfunctions due to alteration, neglect, misuse, abuse, accident, damage during transit or installation, fire, flood, storm, and/or other acts of God. EVEREST is not responsible for any improper electrical connections resulting from electrical power failure, the use of extension cords, and low voltage or voltage drops to the unit.
- G. **UNAUTHORIZED MODIFICATION.** EVEREST is not responsible for the repair or replacement of failed or damaged components resulting from unauthorized modifications to units or the use of non OEM parts without prior written approval from EVEREST.
- H. **IMPROPER ELECTRICAL CONNECTIONS.** EVEREST is not responsible for the repair or replacement of the unit or any damaged components resulting from incorrect supply voltage, low voltage, fluctuating supply voltage, incorrect amperage the use of extension cords, generators or other improper electrical connections.
- I. **OUTSIDE THE U.S.** This warranty does not apply to any parts and/or labor warranty claims made on units sold or used outside of the United States.

These warranties are exclusive and in lieu of all other warranties, expressed or implied, and all other obligations or liabilities on our part, and we neither assume nor authorize any other person to assume for us any other obligation or liability in connection with the sale of said refrigeration units or any part thereof.



**E** **REFRIGERATION**  
**EVEREST**

**A Step Above The Standard**

201 W. Artesia Blvd., Compton, CA 90220

Tel: 800-444-6285 / 310-323-6586

Fax: 310-323-7524 / 310-761-1127

[www.EVERESTref.com](http://www.EVERESTref.com)